

# Facit Twist

## Video Terminal

**Technical description**

**Edition 2**





**NOTES**

In case of any query always consult your service representative.

DEC VT52, DEC VT100 and DEC VT132 are trademarks of Digital Equipment Corporation.

**CONVENTIONS**

The notation used in this document adopts the following conventions.

**(1) Representation of Keyboard Operations.**

Where keyboard operation is described the keys are shown as follows.

- (a) Where the key function is identified by a single character the key will be identified by the same character, without the use of brackets or other delimiters.
- (b) Where the unshifted and shifted functions of a key are both shown on a keytop, the key is identified by its unshifted function (e.g. the [DEL/BS] key will be referred to as the [DEL] key).
- (c) Where the key function is identified by a name the key will be identified by these characters enclosed in square brackets (e.g. [SHIFT]).
- (d) Toggle action keys are identified by the full inscription on the keytop enclosed in square brackets, and where the inscription represents the two toggle states these are separated by a slash, for example [SEND PAGE/LINE].

**(2) Key and Code Functions.** Where the function of an encoded key or a specific code is described, the function will be identified by its ASCII name (for example, the function of the [LINEFEED] key is LF). Where functions of the terminal are described they have names beginning with a capital letter (e.g. Local Mode).

**(3) Key Combinations and Sequences.** Where a key must be depressed simultaneously with another key to obtain a given code or function a + sign is used between the keys to indicate that they must be depressed together, for example [CTRL] + S, [SHIFT] + X. Where no + sign is used the keys shown should be depressed in the sequence indicated (e.g. [ESC] L).

**(4) Character Codes.** All character codes are expressed in Hexadecimal and are shown in the text preceded by the word Hex, for example Hex 08).

**FCC Class B Computing Device: Information to User**

This equipment generates and uses radio frequency energy and if not installed and used properly, that is, in strict accordance with the manufacturer's instructions, may cause interference to radio and television reception. It has been type tested and found to comply with the limits for a Class B computing device in accordance with the specifications in Subpart J of Part 15 of FCC Rules, which are designed to provide reasonable protection against such interference in a residential installation. However, there is no guarantee that interference will not occur in a particular installation. If this equipment does cause interference to radio or television reception, which can be determined by turning the equipment off and on, the user is encouraged to try to correct the interference by one or more of the following measures:

Reorient the receiving antenna.

Relocate the computer with respect to the receiver.

Move the computer into a different outlet so that the computer and receiver are on different branch circuits.

If necessary, the user should consult the dealer or an experienced radio/television technician for additional suggestions. The user may find the following booklet prepared by the Federal Communications Commission helpful:

"How to identify and Resolve Radio-TV Interference Problems".

This booklet is available from the U.S. Government Printing Office, Washington DC 20402.

**Note:** In order to comply with the limits for Class B computing devices pursuant to Subpart J of Part 15 of FCC Rules, please use a shielded cable for interfacing with the host computer.

# CONTENTS

	Page		Page
1. INTRODUCTION	9	6. PRINTING MODES	23
1.1 The Standard Video Terminal Concept	9	6.1 Auto-Print Mode	23
1.2 The New Terminal Concept	9	6.2 Printer Controller Mode	23
		6.3 Expanded Print Mode	23
2. DESCRIPTION	11	7. BLOCK MODE	25
2.1 Microprocessor System	11	7.1 Introduction	25
2.2 Display Generation	11	7.2 Switch Settings	25
2.3 Video Monitor	12	7.3 Block Markers	25
2.4 Keyboard System	12	7.4 Format Mode	25
		8. KEYBOARD	27
3. OPERATING MODES	13	8.1 General	27
3.1 Computer Operation	13	8.2 Alphanumeric Key Pad	28
3.2 Keyboard Operation	13	8.2.1 Character Keys	28
3.2.1 Set-up Mode	13	8.2.2 Modifier Keys	28
3.2.2 On-line Mode	14	8.2.3 Dedicated Function Keys	29
3.2.3 Off-line Mode	14	8.2.4 Transmitted Codes	29
3.2.4 Transparency Mode	14	8.3 Editing Block	30
3.2.5 Self-Testing	14	8.3.1 Cursor Keys	30
		8.3.2 Transmitted Codes	31
4. TRANSMISSION MODES	15	8.4 Numeric Block	32
4.1 Transmission Control	15	8.4.1 Keypad Numeric Mode	32
4.1.1 Transmission from the Terminal	15	8.4.2 Keypad Application Mode	32
4.1.2 Transmission from the Host	15	8.5 Function Keys	32
4.1.3 Half/Full Duplex	15	8.5.1 Program Function Keys	33
4.2 Local Echo	16	8.5.2 User Definable Function Keys	33
4.3 Data reception	17	8.6 Programmable LEDs	33
		9. SET-UP MODE	35
5. DISPLAY HANDLING	19	9.1 Set-up Mode Structure	35
5.1 Screen Handling and Multipage Operation	19	9.1.1 Operator Flexibility	35
5.1.1 Screen Memory	19	9.1.2 Computer Flexibility	35
5.1.2 Display Options	19	9.2 Set-up Modes A,B and C	36
5.1.3 Character Set and Graphic Rendition	19	9.2.1 Introduction	36
5.2 Scrolling	20	9.2.2 General Features	37
5.3 Status Line	20	9.2.3 Set-up Displays	37
		9.2.4 Brightness	37
		9.2.5 On-line/Off-line Operation	37
		9.2.6 Cursor Movement	37
		9.2.7 Save Set-up Parameters	37
		9.2.8 Recall Set-up Features	37

	Page		Page
9.3	38	12.	55
9.3.1	38		
9.3.2	38	12.1	56
9.3.3	38	12.2	56
		12.3	56
9.4	38	12.4	56
9.4.1	38	12.5	57
9.4.2	38	12.6	57
9.4.3	38	12.7	57
		12.8	57
9.5	39	12.9	58
9.5.1	40	12.10	58
9.5.2	42	12.11	58
		12.12	58
9.6	43	12.13	58
9.6.1	43	12.14	59
9.6.2	46	12.15	59
		12.16	59
10.	47	12.17	59
10.1	47	12.18	59
10.2	48	12.19	60
10.2.1	48	12.20	60
10.2.2	48	12.21	60
		12.22	60
10.3	48	12.23	60
10.3.1	48	13.	61
		13.1	61
10.4	49	13.2	61
10.4.1	49	13.3	61
		13.4	62
10.5	49	13.5	62
10.5.1	49	13.6	62
		13.7	62
10.6	50	14.	63
10.6.1	50	14.1	64
10.6.2	51	14.2	64
		14.3	64
10.7	52	14.4	64
		14.5	64
11.	53	14.6	65
11.1	53	14.7	65
11.2	53	14.8	65
11.3	53	14.9	65
11.4	53	14.10	65
11.5	54	14.11	66
		14.12	66
		14.13	66
		14.14	66
		14.15	67
		14.16	67



	Page		Page
15. STATUS LINE	69	18.4 Erase in Line	82
15.1 Status Line On	69	18.5 Home and Clear	82
15.2 Status Line Off	70	18.6 Delete Character	83
15.3 Status Line - Status	70	18.7 Delete Word	83
15.4 Status Line - User	70	18.8 Delete Line	83
15.5 Cursor Position On	70	18.9 Insert Line	83
15.6 Cursor Position Off	70	18.10 Enter Insertion Mode	84
15.7 Time On	71	18.11 Exit Insertion Mode	84
15.8 Time Off	71	18.12 Erase Page	84
15.9 Printer Status On	71	18.13 Erase Line	84
15.10 Printer Status Off	71		
15.11 Transmit Mode On	71	19. CHARACTER AND LINE ATTRIBUTES	85
15.12 Transmit Mode Off	72	19.1 Double Size Line	86
15.13 Interface Monitor On	72	19.2 Single-Width Line	86
15.14 Interface Monitor Off	72	19.3 Double-Width Line	86
15.15 I/O Buffer Monitor On	72	19.4 Select Video	
15.16 I/O Buffer Monitor Off	72	Attributes - ANSI	87
15.17 Terminal Mode On	73	19.5 Select Video	
15.18 Terminal Mode Off	73	Attributes - Custom	87
15.19 Load User	73	19.6 Start Bold Intensity	88
15.20 Load Time	73	19.7 End Bold Intensity	88
		19.8 Start Blinking	88
16. MULTIPAGE HANDLING	75	19.9 End Blinking	88
16.1 Select Flip Page Mode	75	19.10 Start Reverse Video	88
16.2 Select Big Page Mode	75	19.11 End Reverse Video	89
16.3 Advance Pages	75	19.12 Start Underline	89
16.4 Back Pages	76	19.13 End Underline	89
		19.14 Underline Current Character	89
17. KEYBOARD FUNCTIONS	77	19.15 Start Security Field	89
17.1 Keyboard Lock	77	19.16 End Security Field	90
17.2 Keyboard Unlock	77	19.17 Select Character Set - ANSI	90
17.3 Auto-repeat On	78	19.17.1 Select Character Codes - ANSI	91
17.4 Auto-repeat Off	78	19.18 Select Character Set - Custom	91
17.5 Keypad Numeric Mode	78	19.18.1 Enter Semigraphics	92
17.6 Keypad Application Mode	78	19.18.2 Exit Semigraphics	92
17.7 Cursor Keys - Application	78	19.18.3 Select Alternate Char. Gen.	92
17.8 Cursor Keys - Cursor	79	19.18.4 Select Standard Char. Gen.	92
17.9 Load Programmable LEDs	79		
17.10 Flash LEDs	79	20. FORMAT MODE	93
17.11 Extinguish All LEDs	80	20.1 Enter Protection Mode - Custom	93
17.12 Light LED 1	80	20.2 Format Mode - ANSI	
17.13 Light LED 2	80	Protected Attributes	93
17.14 Light LED 3	80	20.3 Exit Protection Mode	
17.15 Light LED 4	80	-Custom and ANSI	94
		20.4 Bold Protected	94
18. EDITING FUNCTIONS	81	20.5 Underline Protected	94
18.1 Erasure Mode - Unprot. Only	81	20.6 Blink Protected	94
18.2 Erasure Mode - All	81	20.7 Reverse Video Protected	94
18.3 Erase in Display	82	20.8 All Attributes Off Protected	95
		20.9 Blank Protected	95
		20.10 Reset Custom Protected	
		Attributes	95



	Page		Page
21. SET AND RESET MODE COMMANDS	97	25. DOWNLINE LOADING	113
21.1 Set and Reset - Part I	97	25.1 User Definable Function Keys	113
21.1.1 Reset Mode 1	97	25.2 Command Codes	114
21.1.2 Set Mode 1	97	25.3 Report EAROM	114
21.2 Set and Reset - Part II	100	26. INTERFACE INFORMATION	115
21.2.1 Keypad Application Mode	100	26.1 V.24/RS-232-C Communication Interface	115
21.2.2 Keypad Numeric Mode	100	26.2 V.24/RS-232-C Printer Interface	116
21.2.3 Enter ANSI Mode	100	26.3 I/O Current Loop Interface	116
21.2.4 Enter Custom Mode	100	27. INSTALLATION	117
21.3 Set and Reset - Part III	101	27.1 Initial Setting Up	117
21.3.1 Reset Mode 2	101	27.2 Access to Main Logic Board in Display Unit	117
21.3.2 Set Mode 2	101	27.3 Access to Keyboard Circuit Board	117
22. REPORT COMMANDS	103	27.4 Keyclick/Bell Volume Adjustment	117
22.1 Cursor Position Report	103	27.5 Brief Operating Instructions	117
22.2 Report Display Mode	103	28. TECHNICAL SPECIFICATION	119
22.3 Device Status Report	104	29. JUMPERS	121
22.4 Device Attributes	104	29.1 Main Logic Board	121
22.5 Printer Status Report	104	29.2 Keyboard Circuit Board	121
22.6 Load Response	105		
23. RESET AND TEST COMMANDS	107		
23.1 Reset Terminal	107		
23.2 Screen Alignment Display	107		
23.3 Invoke Tests	107		
23.4 Request Terminal Parameters	108		
24. PRINT COMMANDS	109		
24.1 Print Line	109		
24.2 Print Page	109		
24.3 Enter Auto-Print Mode	110		
24.4 Exit Auto-Print Mode	110		
24.5 Enter Printer Controller Mode	110		
24.6 Exit Printer Controller Mode	110		
24.7 Enter Expanded Print Mode	110		
24.8 Exit Expanded Print Mode	111		
24.9 Print Termination Char. - FF	111		
24.10 Print Termination Char. - None	111		
24.11 Print Extent - Screen	111		
24.12 Print Extent - Region	111		
24.13 Print Active Page	112		
24.14 Print All Pages	112		



		Page			Page
<b><u>APPENDIXES</u></b>			<b><u>LIST OF FIGURES</u></b>		
<b>APPENDIX 1</b>	<b>National Keyboards and Code Tables</b>	123	<b>Fig. 1</b>	<b>The Terminal: General View</b>	9
			<b>Fig. 2</b>	<b>Tilt, Lift and Twist Movements</b>	10
			<b>Fig. 3</b>	<b>Portrait and Landscape Formats</b>	11
<b>APPENDIX 2</b>	<b>Summary of Terminal Control Functions</b>	125	<b>Fig. 4</b>	<b>General View of Keyboard</b>	12
			<b>Fig. 5</b>	<b>Typical Set-up Mode Display</b>	13
<b>APPENDIX 3</b>	<b>Summary of Set-up Functions</b>	133	<b>Fig. 6</b>	<b>Typical Custom Mode Display</b>	13
			<b>Fig. 7</b>	<b>Half and Full Duplex</b>	15
<b>APPENDIX 4</b>	<b>Control and Character Code Tables</b>	135	<b>Fig. 8</b>	<b>Local Echo</b>	16
			<b>Fig. 9</b>	<b>Twist Screen Memory and Displays</b>	18
<b>APPENDIX 5</b>	<b>Graphics Mode Symbols</b>	137	<b>Fig. 10</b>	<b>Alternative Character Matrixes</b>	19
			<b>Fig. 11</b>	<b>Typical Status Line</b>	20
			<b>Fig. 12</b>	<b>Print Switch Combinations</b>	22
			<b>Fig. 13</b>	<b>Block Mode Switch Combinations</b>	24
			<b>Fig. 14</b>	<b>Keyboard Functional Areas</b>	27
			<b>Fig. 15</b>	<b>Alphanumeric Key Pad</b>	28
			<b>Fig. 16</b>	<b>Editing Block</b>	30
			<b>Fig. 17</b>	<b>Numeric Block - Numeric Mode</b>	32
			<b>Fig. 18</b>	<b>Numeric Block - Application Mode</b>	32
			<b>Fig. 19</b>	<b>Function Keys</b>	32
			<b>Fig. 20</b>	<b>Set-up Mode Functions</b>	34
			<b>Fig. 21</b>	<b>Set-up Mode Structure</b>	35
			<b>Fig. 22</b>	<b>Operator Selections in Set-Up Mode</b>	36
			<b>Fig. 23</b>	<b>Set-up A Display</b>	38
			<b>Fig. 24</b>	<b>Set-up B Display</b>	39
			<b>Fig. 25</b>	<b>Set-up C Display</b>	43
			<b>Fig. 26</b>	<b>Customized Codes Assignment and Storage in EAROM</b>	47
			<b>Fig. 27</b>	<b>Custom Mode Set-up 1 Display</b>	48
			<b>Fig. 28</b>	<b>Custom Mode Set-up 2 Display</b>	49
			<b>Fig. 29</b>	<b>Custom Mode Set-up 3 Display</b>	49
			<b>Fig. 30</b>	<b>Custom Mode Set-up 4 Display</b>	50
			<b>Fig. 31</b>	<b>ANSI Character Set Selection</b>	90
			<b>Fig. 32</b>	<b>Custom Character Set Selection</b>	91
			<b>Fig. 33</b>	<b>Location of Interface Connectors</b>	115
			<b>Fig. 34</b>	<b>I/O Connector Pin Allocations</b>	115
			<b>Fig. 35</b>	<b>Printer Connector Pin Allocations</b>	116
			<b>Fig. 36</b>	<b>3-pin Jumper Notation</b>	121
			<b>Fig. 37</b>	<b>Location of Jumpers on Main Logic Board</b>	122
			<b>Fig. 38</b>	<b>Location of Jumpers on Keyboard Circuit Board</b>	122





# 1. INTRODUCTION

## 1.1 THE STANDARD VIDEO TERMINAL CONCEPT

The basic requirements of a video terminal are to display, enter and modify information.

With the strongly evolving office automation and microcomputer market, it is becoming more and more evident that these basic requirements can - and will - be seen from new angles.

In functional terms this means the introduction of multi purpose workstations, with text processing and traditional data processing all done by the same operator.

In ergonomic terms it will result in greater pressure for good visualization of information. Not only, as is mostly heard in the current debate, better legibility of characters, but also a higher degree of perception for the user of the total volume and layout of the information.

## 1.2 THE NEW TERMINAL CONCEPT

The new terminal concept embraces an asynchronous ASCII video terminal with a large dual display format (A4 size portrait/landscape) and a separate superslim keyboard.

The display unit includes all the necessary logic and electronics and is integrated with a unique 15 inch, 40 MHz bandwidth, high resolution (20 x 16 character matrix) monitor. The display tube has a direct etched faceplate giving excellent glare protection, and operates with a 65Hz refresh rate to ensure a flicker-free screen with superb video quality in a black-on-white image.

The monitor integration is a state-of-the-art solution that allows the monitor to be tilted, lifted and even twisted - with perfect balance and ease - and yet with a footprint which is strikingly small for a 15 inch video terminal.



A new video terminal concept

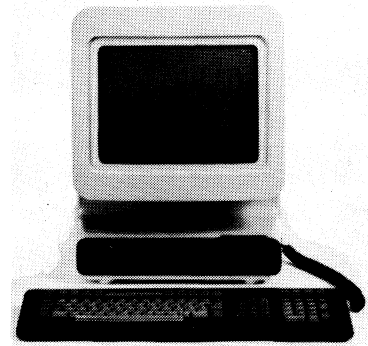

Landscape Format: 24 lines

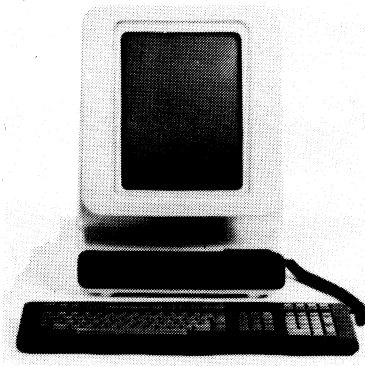

Portrait Format: 72 lines

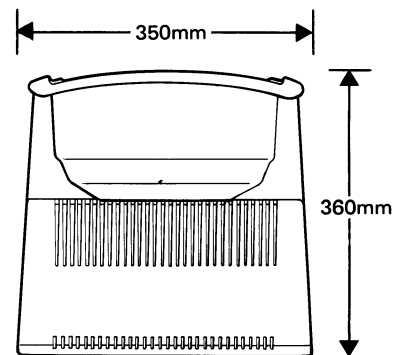

Footprint

Fig.1 The Terminal: General View



With its "twist" capability the terminal can be used not only for conventional data processing in landscape format (24 lines by 80 characters), but also in portrait format (72 lines by 80 characters) for word processing applications. In practice this means that you can use the conventional landscape format when there is a need to display the information with large detailed characters and the highest character resolution possible, and then "twist" the monitor so that it displays the volume and layout of the information in true A4 portrait format.

The versatility of the concept is not limited to appearance and mechanical knowhow, it also includes advanced page handling and an extremely flexible selection of command protocols. A multipage feature allows the user to partition the memory into three separate pages for conventional data processing - or as one large "Big Page" for word processing applications.

For host computer adaptability the terminal can operate in ANSI, Custom or Custom Reassigned Modes. Not only is it possible to shift between these modes at any time, but the user can also assign a command set tailored exactly to a particular computer, terminal driver or application program. The Set-up function can be made from either the host computer or from the keyboard, and stored in nonvolatile memory. The Set-up flexibility also extends itself to the keyboard where there are 12 soft-definable function keys available for a total of 36 different function strings.

Furthermore the concept includes character-by-character (Interactive) or Block Mode transmission, a variety of interfaces - V.24/RS-232-C and Current Loop - with baud rates up to 19200 bps, split speed possibilities and choice of line protocols between XON/XOFF, Ready/Busy and Modem control.

This flexibility doesn't end with host computer adaptability, it also extends to, and enhances, the printer handling. All the well known features are there - Print line/page, Auto Print mode, Printer controller mode - naturally extended to handle the multipage capability. The enhancements lie mainly in the local area, thus extending the possibilities for the operator. The standard local print command set has therefore been increased with the Expanded Print Mode - where attribute codes and character set controls are interleaved in the datastream to make possible a locally initiated "true" printout.

The keyboard is separate, superslim, slightly tilted and includes an integrated palm rest. Thorough research and experience has resulted in a layout giving superb ease of handling and reliability - separate typewriter-style alphanumeric key pad, cursor control and editing block, numeric block, three groups of function keys, five LED's for terminal control and supervision - and still with overall dimensions that fit a busy office desk.

Not only can the keyboard be configured in a selection of national versions, but it can also be tailored to a variety of tasks through use of the function keys; 36 operator or host definable strings are available.

In developing the concept we have gone to great lengths just to let common sense determine the design of a video display terminal tailored to one specific task - to let the user communicate with a computer.

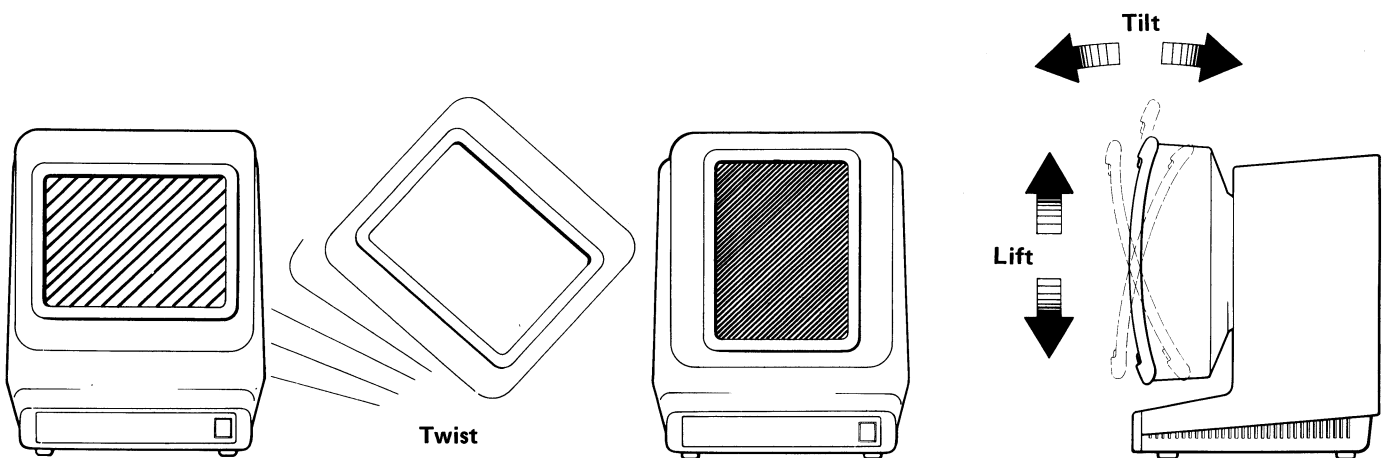

Fig.2 Tilt, Lift and Twist Movements

## 2. DESCRIPTION

### 2.1 MICROPROCESSOR SYSTEM

The microprocessor system controls all the terminal functions and defines the operating characteristics of the terminal. It is built up around a 4 MHz Z80A microprocessor with up to 32 kbytes of program memory, 16 kbytes of RAM and 350 bytes of non-volatile memory. Communications between the host computer, printer and keyboard are handled by DART-based I/O logic and the display is driven by a non-standard video combiner circuit, which is controlled by a CRT controller.

### 2.2 DISPLAY GENERATION

All character positions (cells) on the display screen are memory-mapped onto 6k x 16 bits screen RAM, with each page occupying 2k x 16 bits and each cell 16 bits. Each memory cell uses one bit to indicate the character set, and 7 bits to indicate the basic character code. The remaining 8 bits in the cell are used to indicate character and field attributes. This allows the terminal to display up to 256 different characters simultaneously, each with its own attributes.

The displayed characters are made up from a pattern of dots, 20 high by 16 wide in the landscape format and 16 high by 7 wide in the portrait format. The character dot patterns are stored in a look-up table

in the character generator ROM, from which they are collected according to the screen map information and then displayed on the screen, scanline by scanline. The whole process is repeated at a rate of 65 Hz, thus striking a balance between the persistence of the display phosphor and the refresh rate. This carefully selected balance ensures a flickerfree screen that allows any change on the screen to appear instantaneous to the operator.

When the data on the screen is moved (upwards or downwards as new lines of data are entered) this can occur textline by textline - jumpscroll, or scanline by scanline - smooth scroll. Smooth scrolling moves the data slowly on the screen to allow simultaneous reading, and can be set to fast (12 lines per second) or slow (6 lines per second). (Smooth scrolling is not available in portrait format).

It is also possible to select a particular portion of the display area (including the whole area) for scrolling, this area being known as the scrolling region. Within this region scrolling is performed, whilst data positioned outside the region remains stationary. The cursor is constrained to movement within the scrolling region during normal data entry, thus the text outside the scrolling region cannot be altered unless the scrolling boundaries are (temporarily) extended to include this text.

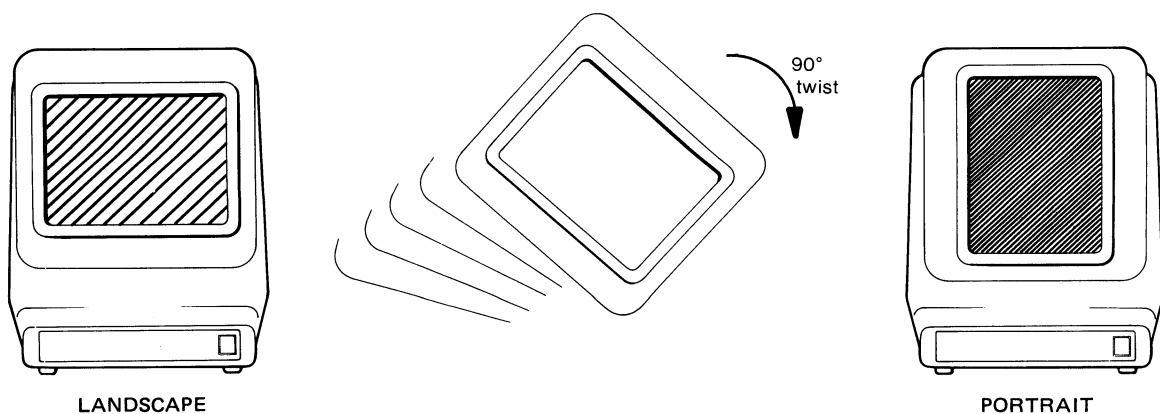

**Fig.3 Portrait and Landscape Formats**



### 2.3 VIDEO MONITOR

The video monitor is of advanced design, with a video bandwidth of 40 MHz, high resolution and excellent linearity. It consists of a video electronics board including EHT power supply and a display tube. The display screen measures 15 inches diagonally with a direct etched faceplate for excellent glare protection, and operates at a 65 Hz refresh rate to ensure a flickerfree screen giving superb video quality. The display area is adjusted to fill the whole visible area of 200 x 275 mm (8 x 11 inches) when the monitor is mounted in the cabinet. A screen saver, which can be enabled or disabled, is incorporated. This blanks the screen after 10 minutes inactivity; the display is restored immediately data is received or the keyboard is used.

### 2.4 KEYBOARD SYSTEM

The keyboard is a separate item connected to the display unit by a flexible coiled cable.

A choice of national keyboard styles is available, covering all major European and American requirements. A single chip processor built in to the keyboard encodes the key matrix according to which national version is in use, and reports key depressions to the display unit. The report is transmitted in serial format (at 2400 bps) where it is received by DART-based I/O logic. Some communication

also takes place in the reverse direction, from the display unit to the keyboard, to control the status LEDs.

Physically, the keyboard is designed with an integrated palm rest, but it is still very thin (less than 30 mm) and has two possible tilt angles. The keys are laid out in functional blocks, consisting of an ergonomically refined alphanumeric keypad with 58 keys, a separate cursor and editing block with the cursor control keys in an "inverted T" configuration, a numeric block (18 keys), two groups of assignable function keys and LEDs above the alphanumeric pad, and a further group of four assignable function keys at the top right. The keyboard also features 3-key rollover and selectable auto-repeat. The overall flexibility of the keyboard and its carefully considered layout provides the user with a comfortable and convenient means of entering data and interacting with the host computer regardless of the particular application.

Primarily the keyboard enables the operator to send coded data to the host, and to control the functions of the terminal and its communications. The keyboard is, however, also used in a special Set-up mode to set up the basic operational parameters of the terminal and to program the desired Custom Mode command protocol as well as defining the "soft keys".

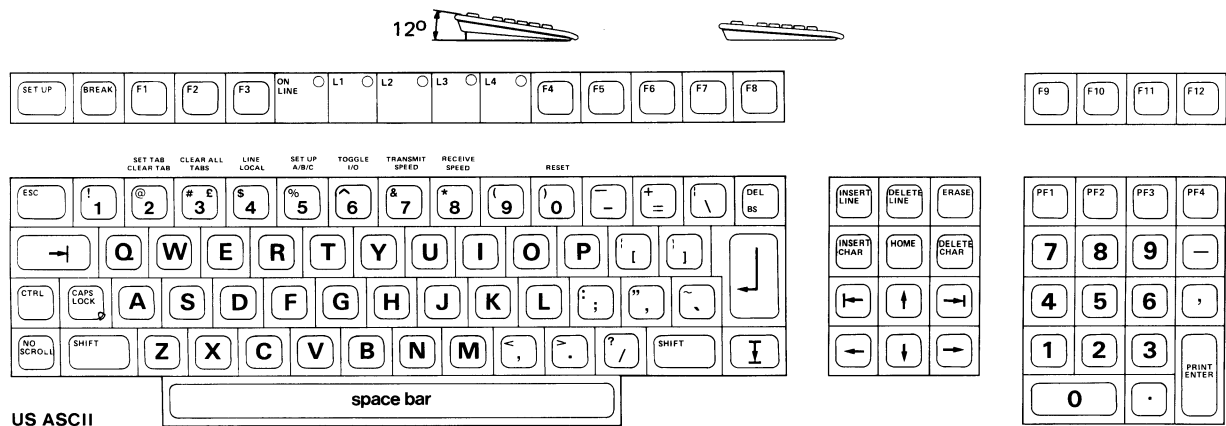

Fig.4 General View of Keyboard (US ASCII Version)

### 3. OPERATING MODES

#### 3.1 COMPUTER OPERATION

The terminal can basically operate in ANSI Mode or in Custom Mode, with all fundamental functions available in both Modes. The ANSI Mode includes the basic DEC VT100/VT132 concept with editing and printer handling commands. In the Custom mode an alternative default set of commands, basically 2-byte commands, are resident in the terminal.

By means of Custom Mode programming the default set of Custom commands can be reassigned to other customer specified commands or command strings. The user can even inhibit one, or any number of functions. During Custom Mode programming the operator (or host) is kept informed of the remaining memory, as there are no fixed memory partitions for re-assignment of commands or command strings. The programmed Custom set is then stored, temporarily or permanently as desired. Custom Mode programming also extends to programming of the "soft" keyboard keys; see Section 8, Keyboard, for details.

#### 3.2 KEYBOARD OPERATION

From the operator's viewpoint, there are three different basic modes of operation available - Set-up, On-line and Off-line. The operator can determine the basic mode of operation of the terminal from the keyboard.

##### 3.2.1 SET-UP MODE

The terminal does not employ hardware switches to set its operational parameters, instead these are set

by the user on software controlled switches via the Set-up Mode. On entry to the Set-up Mode the current switch values are displayed on the screen (the On-line/Off-line status is shown by means of the keyboard LED).

So that the user can ensure a given initial state for all parameters when the terminal is switched on, the required values are stored in non-volatile memory, so that data will be preserved even when the power is off. The user may at any time change any of the current operational parameters - temporarily or permanently as desired. (There is also a jumper available on the logic board that inhibits a permanent change of Set-up values.) When the Set-up Mode has been entered there are three menus available: Set-up A, Set-up B and Set-up C. Initially Set-up A is displayed. For each of the Set-up menus all the possible parameter selections (more than 50 excluding the Custom Mode) are expressed in plain English (except the brightness setting).

If Custom Mode programming has been selected in the Set-up Mode, the Custom Mode menu set becomes available. The operator can now change the code or code-string assignments for all available functions as well as changing the function strings and key definitions for soft-definable keys on the keyboard. During Custom Mode programming both the old and new values are displayed function by function, as well as the count down of available memory - as there are no fixed partitions for custom assignment. Custom mode programming can also be performed from the host computer.

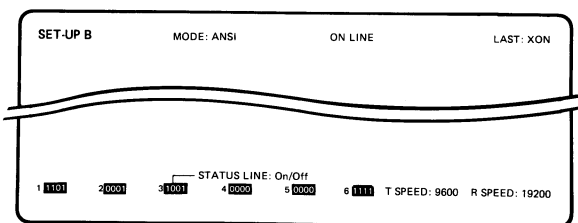

Fig.5 Typical Set-up Mode Display

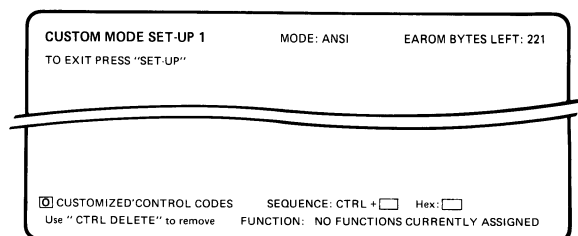

Fig.6 Typical Custom Mode Display

### 3.2.2 ON-LINE MODE

The On-line Mode can be considered as the normal operating mode of the terminal. In this mode it is connected to the host via the communication line, can transmit data to the host and will respond to commands and data sent from the host. In addition to normal On-line operation, all available Custom Mode definitions can also be downloaded from the host computer.

#### Interactive Mode

When the terminal is in the Interactive Mode any key depression causes the character or command to be sent to the host (when the line is ready to accept transmission) and is simultaneously (with Local or Remote Echo) passed to the terminal for display or action as appropriate. Data transmission to the host is therefore character by character.

#### Block Mode

In Block Mode data from the keyboard is accumulated in the terminal and sent to the host by means of the ENTER or CR keys in blocks, which may be complete lines or pages as determined by the Send Extent setting (refer to Section 7, Block Mode for full details).

In Block Mode the terminal is always ready to receive data and commands from the host.

### 3.2.3 OFF-LINE MODE

When Off-line the terminal is not able to communicate with the host. The keyboard is active and characters will be displayed on the screen as they are typed. In this mode, command sequences can be typed on the keyboard to obtain the appropriate response from the terminal. It will not respond to data or commands from the host.

The code string from the global function keys and PF1 to PF4, cannot be displayed on the screen in either Local or Block Modes.

### 3.2.4 TRANSPARENCY MODE

The Transparency Mode is entered via the Set-up Mode, and allows all data received from the host, including control codes and escape sequences, to be displayed. Control codes are displayed in reverse video as a \* followed by the displayable character that has the same lower 5 bits as the control code in question. For example, "SOH" is displayed as \*A in reverse video (corresponding to the control code Hex 01). This Mode can be most useful during software debugging, as the control codes and escape sequences are all shown.

**Note:** All local commands from the terminal can be displayed except function keys F1 to F12 and PF1 to PF4, regardless if they are unshifted, shifted or used with control.

#### NORMAL

Enter [ESC] [H]

Display response: Tab stop inserted at cursor position.

#### TRANSPARENT

Enter [ESC] [H]

Display response: \*[H

#### Transparency Mode Display

### 3.2.5 SELF-TESTING

Self-testing is performed automatically at power-up and at any other time at the request of the operator.



## 4. TRANSMISSION MODES

The terminal may be set either On-line or Off-line, as determined by the On-line/Off-line switch. When the terminal is On-line, transmission can be Interactive (character by character, with local or remote echo) or in blocks of characters (Block Mode), as determined by the parameter setting. When the terminal is Off-line data transmissions between the terminal and the host are not possible.

### 4.1 TRANSMISSION CONTROL

#### 4.1.1 TRANSMISSION FROM THE TERMINAL

When the terminal is On-line, in either Interactive or Block Mode, transmission from the terminal can be inhibited (by either the host or the modem) by setting the CTS (clear to send) line low. When CTS is high, or not connected, transmission from the terminal is always possible.

#### 4.1.2 TRANSMISSION FROM THE HOST

Transmission of data from the host can be inhibited by the terminal through sending XOFF or setting the Ready/Busy-line low, depending on the selected protocol. This can occur under operator control, but normally the ready or busy status of the terminal will be signalled automatically by the buffer logic.

#### 4.1.3 HALF/FULL DUPLEX

When the terminal is On-line, in either Interactive or Block Mode, the terminal can communicate in full duplex or half duplex. The difference between full and half duplex is the modem control - in full duplex the RTS (request to send) line is always high, and in half duplex the RTS line is pulled low after a time out (xx seconds) or after transmission of CR, ETX, EOT or STX. The RTS line is pulled high immediately a key is pressed.

#### HALF DUPLEX

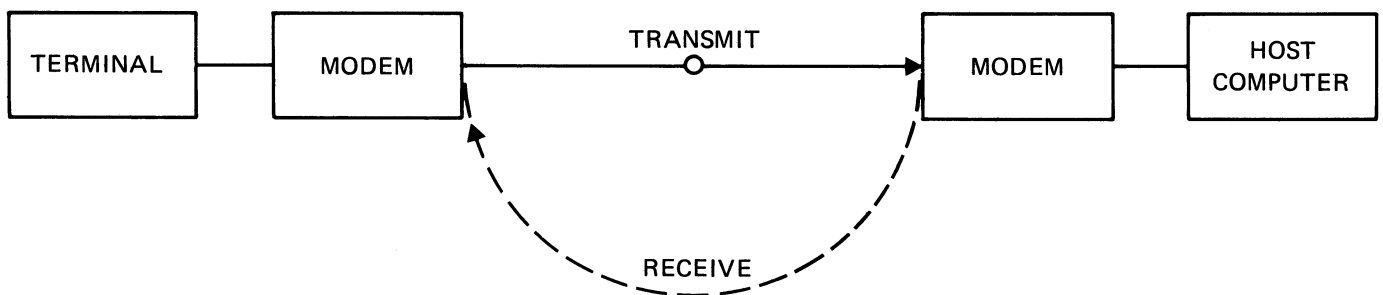

#### FULL DUPLEX

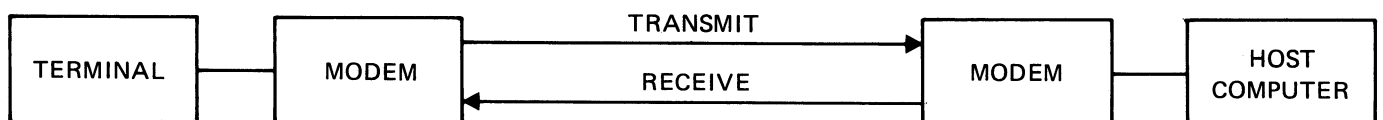
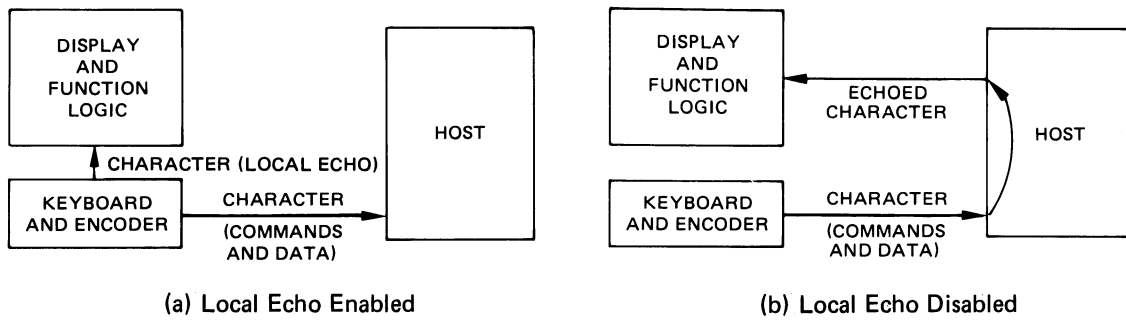

Fig.7 Half and Full Duplex

## 4.2 LOCAL ECHO

When Local Echo is enabled (see Switch B:5.1 in Section 9.5.1, Set-up B Switches), all data sent via the I/O Port will also be echoed locally (via the terminal) to the display. Otherwise data will be directly sent out from the I/O Port and will not be displayed until the host has echoed the character back to the terminal via the communication link and any parity (if enabled) has been verified.



**Fig.8 Local Echo**

### 4.3 DATA RECEPTION

Data will only be accepted from the host whilst the terminal is On-line. The buffer size (256 characters) is sufficient to ensure that no characters are lost even at the highest data transmission rates provided that the host is working to the XON/XOFF or Ready/Busy protocols. Thus whenever the buffer has filled up to 128 characters the terminal sends an XOFF signal and lowers the Busy line, to tell the host to stop transmitting. The remaining buffer space allows further characters to be received until the host has had time to respond.

An emergency XOFF and low Busy line signal is sent when the buffer is filled to 228 characters, whereupon the terminal automatically changes to jump scroll to ensure that all the received data is shown on the screen, even though its reception rate may be very high.

If the buffer overflows an error marker is displayed on the screen and the buffer is cleared. The Printer Controller Mode is exited and any remaining print data is displayed on the screen.



### BIG PAGE MODE

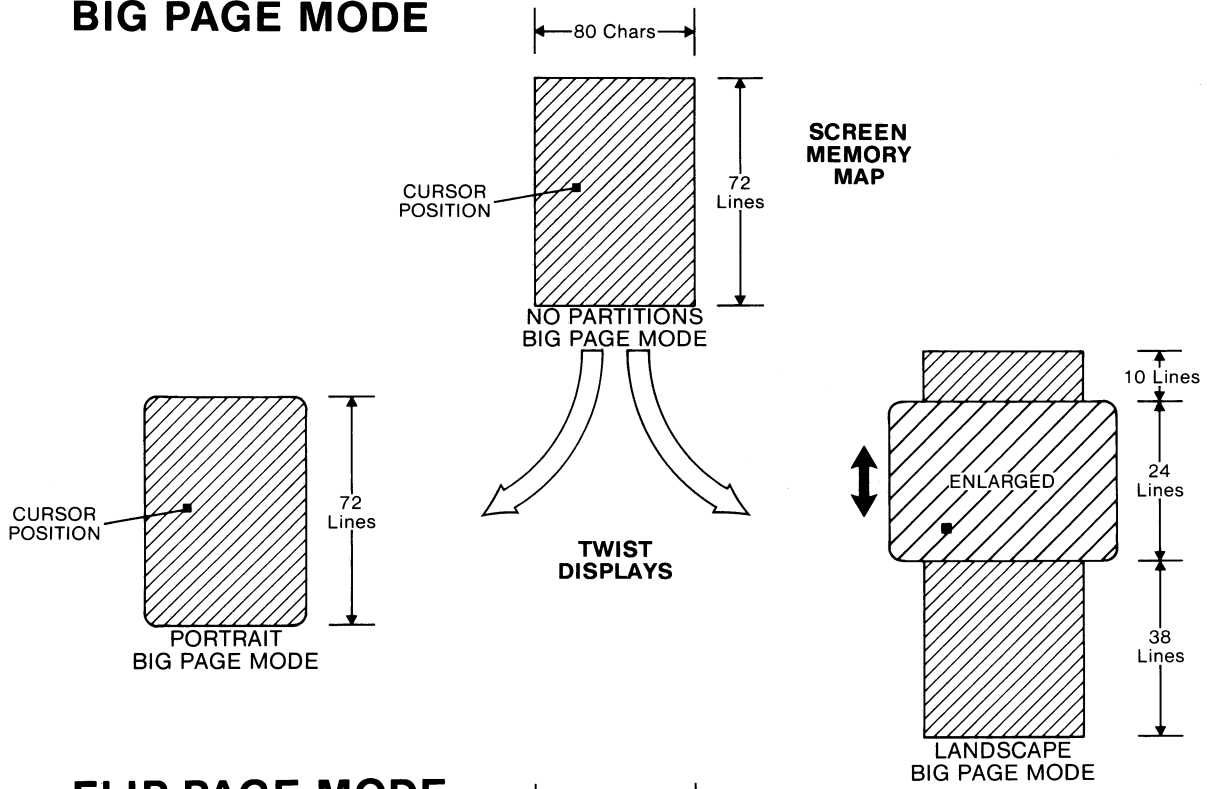

### FLIP PAGE MODE

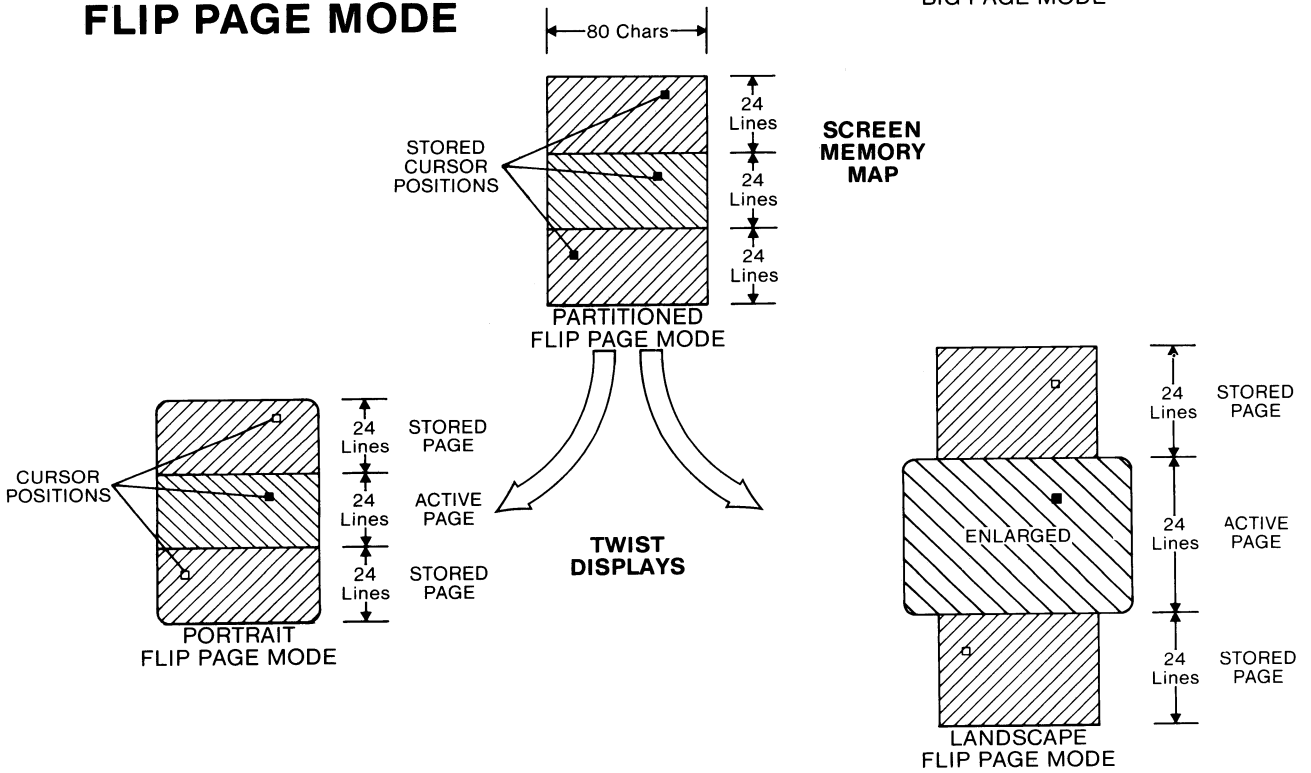

Fig.9 Twist Screen Memory and Displays

## 5. DISPLAY HANDLING

### 5.1 SCREEN HANDLING AND MULTIPAGE OPERATION

#### 5.1.1 SCREEN MEMORY

The terminal contains 6k x 16 bits of memory reserved for the screen contents. This constitutes a screen map in memory, containing both character and attribute information, together with a note of the cursor position, stored according to the position on the screen of each character.

The memory has two possible formats, dependent on whether the Big Page or Flip Page Mode has been selected. This selection may be made either by the host computer or by the operator, via the Set-up Mode. In the Big Page Mode the memory has no partitions, and therefore maps a full A4 size page of 72 lines by 80 characters (5760 cells), and memorizes one cursor position.

In the Flip Page Mode the memory map is partitioned so as to contain three separate sets of 24 lines, each line having 80 characters. Only one of these sets of 1920 cells (Flip Pages) is active at any one time, and the active page has a visible cursor. The inactive pages also have cursor positions held in the memory, but these remain suppressed (do not appear on the screen) until one of these pages is called forward to be active. Each of the Flip Pages also maintains its own character set selections, video attributes, scrolling region, left and right margins and page scroll mode.

#### 5.1.2 DISPLAY OPTIONS

The "twist" capability permits the user to have either a **Portrait** or a **Landscape** screen display format. Naturally the choice between these displays is entirely up to the operator, and is independent of whether Big Page or Flip Page Mode has been selected. Any display change (from Portrait to Landscape or vice versa) may also be reported to the host computer. In the **Big Page Mode** the **Portrait** display shows the whole of the screen memory map contents, simulating an A4 Portrait page of 72 lines by 80 columns, with one cursor.

If the operator turns the screen through 90 degrees, the **Big Page Mode Landscape** display then shows a 24-line section of the memory map contents (the section containing the cursor), enlarged so that the characters are easier to read. The cursor can be moved up or down to the top or bottom edges of the display to "move" the display over the stored page and reveal the hidden text as required.

If **Flip Page Mode** has been selected, the **Portrait** display shows all three partitioned pages of 24 lines each, but only the active page has a visible cursor. The cursor will not move beyond the top or bottom of the active page. In **Block Mode** the shifted cursor controls can be used to move to the previous or next pages as desired. In this case the hitherto invisible cursor is revealed to show that this is the currently active page. The active page can be changed either from the keyboard or the host.

When the display is twisted 90 degrees to **Landscape** in the **Flip Page Mode**, only the 24 lines of the active page are shown, with enlarged characters.

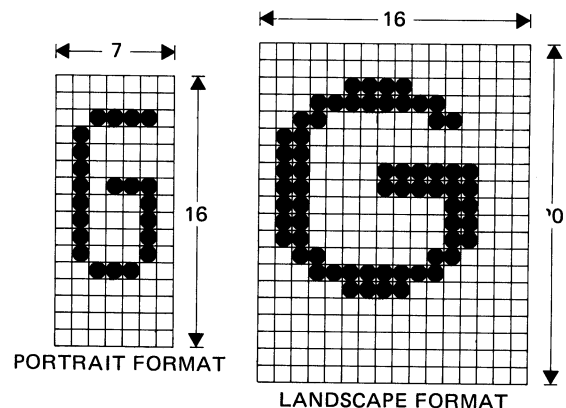

Fig.10 Alternative Character Matrixes

#### 5.1.3 CHARACTER SET AND GRAPHIC RENDITION

The standard character set includes a basic 96 character national set and a 32 character graphic set. With the addition of an extended character generator, the available character sets are doubled to a total of 256 characters (all of which can be displayed on the screen simultaneously). Any two of the available character sets can be selected as primary sets, whereafter shifting between the two sets is done with SI (Shift In) and SO (Shift Out) commands.

In both Landscape and Portrait Modes all characters may be preset to have any attribute or combination of attributes such as bold, underlined, blink, reverse video and blank (nondisplayed). This graphic rendition can be changed at the character level, without consuming a character position in the screen map RAM.

In the Landscape Mode lines of text can also be set to have normal size, double width only or double width and double height.

## 5.2 SCROLLING

When the monitor is turned to the Landscape Format scrolling may occur in any of three ways, depending on the setting of the scroll parameters. Jump scrolling moves the text on to or off the screen line by line; fast smooth scroll moves the data at 12 lines per second but more gradually, with a line of text moving up or down one dot row at a time; and slow smooth scroll gives the same effect but at 6 lines per second. Smooth scrolling is not available in the Portrait Format.

It is possible to select a particular portion of the display area for scrolling, if the whole area is not required to scroll. The selected area is then known as the scrolling region, and data outside this region remains stationary. The cursor may only move within the scrolling region whilst data is being entered, thus the text outside the scrolling region cannot be altered unless the scrolling boundaries are (temporarily) extended to include this text.

The scroll parameters are determined by soft switches in Set-up B (see Section 9.5.1) and in Custom Mode Set-up 4 (Section 10.6.2). See also Section 20, Set and Reset Mode Commands.

## 5.3 STATUS LINE

The Status line provides the operator with an extra line of status information that is displayed at the bottom of the screen. The Status line can be used to show either User status or Terminal and System status, and can be turned on or off by the operator or by the host. When used to show Terminal and System status it may contain a selection from the following information:

**Cursor position** Defined as Page (1-3), Row (1-24/72) and Column (1-80)

**Clock** A digital 24 hour clock read-out is located on the Status line. The clock is set by the Load Time command.

- Terminal mode**
  - Insert (ON/OFF) indicates whether the terminal is in "Insert" or "Replacement" mode.
  - Keypad (NUM/APPL) indicates whether the numeric keypad is set for "Numeric" or "Application" mode.
- Printer status**
  - "OFF" indicates that the Print Mode is not selected.
  - "AUTO" indicates Auto Print Mode selected.
  - "CNTR" indicates Printer Controller Mode selected.
  - "PART" indicates the print extent.
  - "LINE" indicates the print line.
  - "PAGE" indicates the print page.
- Transmit mode**
  - OFF indicates Local Mode (Off-line).
  - "CHAR" indicates On-line character-by-character mode.
  - "ALL" indicates Block Mode and "SEND ALL". If "ALL" is displayed in reverse video, that indicates Format mode is on.
  - "PART" indicates Block mode and "SEND PARTIAL". If "PART" is displayed in reverse video, that indicates Format mode is on.

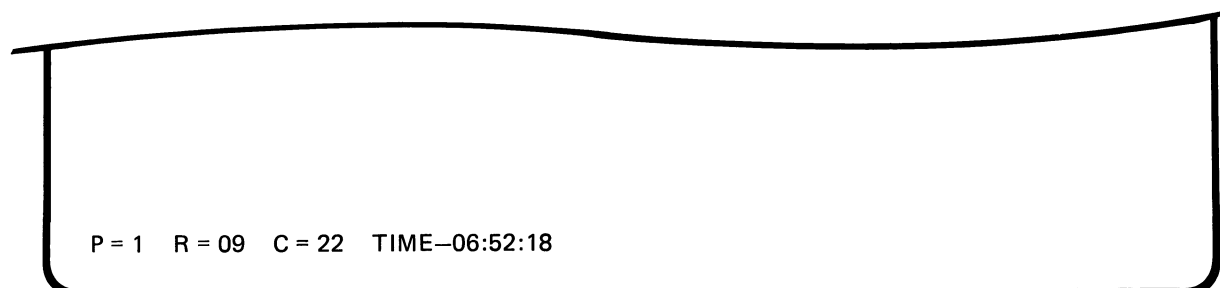

Fig. 11 Typical Status Line

- Interface** - P (RDY/BSY) displays "Bsy" if the last protocol character from the printer was "XOFF" or if the logic level on pin 19 of the printer is low. Otherwise "Rdy" is displayed.
- I/O (XON/XOFF) displays the last transmitted protocol character from the host.
  - CTS (LOW/HIGH) indicates whether the logic level on pin 5 of the I/O interface is low or high.

**Note:** If the Printer status, Interface or Transmit mode status line display is flashing, this indicates that an operation is in progress. If continuously flashing this indicates that the printer or host is busy or is not connected.

- Buffer** - The available capacity of the terminal's internal buffer is indicated by an 8-level bar graph with 32 characters for each level. When the input buffer contains 160 or more characters the bar graph is displayed in reverse video and flashes. If the input buffer overflows, an error marker will be inserted in the data stream (and thus will be displayed in the text on the screen at the point where the data has overflowed).



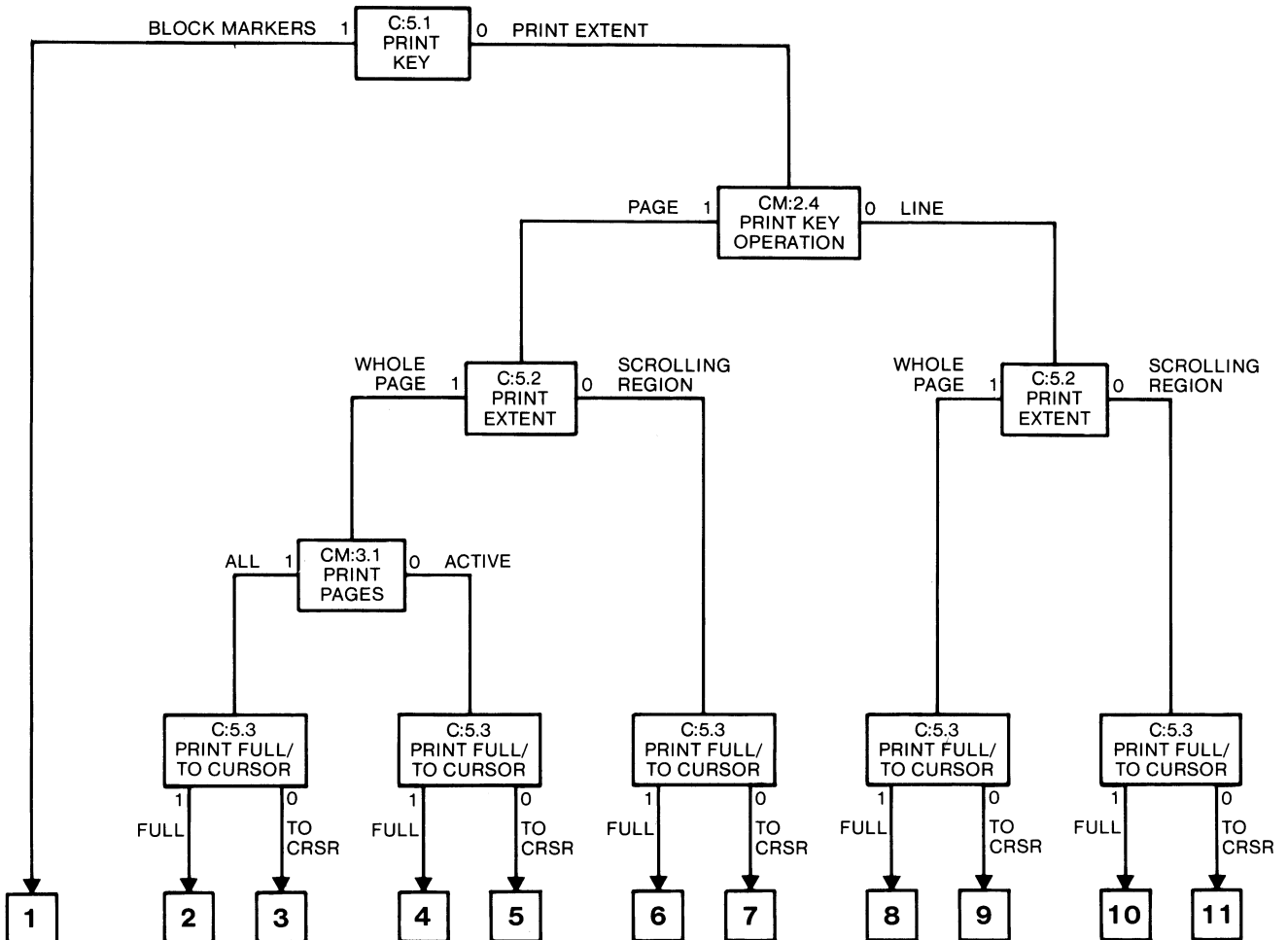

#### PRINT POSSIBILITIES

1. Print between block markers (i.e. from previous block marker to current cursor position).
2. Print complete screen display, even inactive pages.
3. Print complete screen display, even inactive pages, up to the current cursor position.
4. Print whole active page.
5. Print active page up to current cursor position.
6. Print whole scrolling region.
7. Print scrolling region up to current cursor position.
8. Print complete line indicated by cursor.
9. Print indicated line up to current cursor position.
10. Print complete line indicated by cursor, if it lies within the scrolling region.
11. Print indicated line up to current cursor position, if it lies within the scrolling region.

Fig. 12 Print Switch Combinations

## 6. PRINTING MODES

The printing modes in the terminal provide the user with the possibility to connect and use a printer for both hard copy - screen dump - as well as more system/application-oriented printer tasks.

The terminal printing functions can be divided into three main groups:

### Selection Functions

PRINT key: Block or line/page.

Print extent: All or scrolling region.

Print line/page extent: All or up to cursor.

Print pages: All or active page.

Print termination: FF or none.

Expanded Print Mode: On or off.

### Print Functions, Remote Commands

Print line, print page, Auto-print Mode, Printer Controller Mode.

### Print Functions, Local Commands

Print block/line/page, enter or exit Auto-print Mode, print screen page (prints visible screen page - not affected by print extent).

### Normal Print Attributes

Double height characters are printed as two identical lines of normal height, and double width characters are printed as normal width characters. Semigraphic characters are printed out as asterisks (Hex 2A). Other character attributes are not sent out to the printer. Note that character set shifts on the screen are not sent out to the printer.

### 6.1 AUTO-PRINT MODE

In Auto-print Mode, each line of data displayed on the screen is automatically printed whenever the cursor is moved off that line (by LF, FF or VT control codes).

### 6.2 PRINTER CONTROLLER MODE

In this Mode data received from the host is not displayed on the screen but is routed directly to the printer. If no printer is connected then the data is displayed.

If the operator enters data via the keyboard, this data is not displayed but is routed to the host, thus allowing the operator to communicate with the host.

### 6.3 EXPANDED PRINT MODE

With the "Expanded Print Mode" enabled, it is possible to send out all data on the screen to the printer port, formatted with interleaved codes at all transitions between character set shifts/attribute shifts. This simulates a "photo-image" of the screen when the terminal is used together with the 4510 - 4512 range of printers.

For normal/semigraphic characters the normal characters are sent out as the normal ASCII codes and the semigraphic characters are sent out in the form of control codes, as they are stored in the screen RAM - but with bits 6 and 7 set to 1 (i.e. column 0 and 1, transferred to column 6 and 7) - preceded and followed by appropriate escape sequences. For semigraphic characters to be printed out correctly, the printer must be equipped with the corresponding optional character generator.

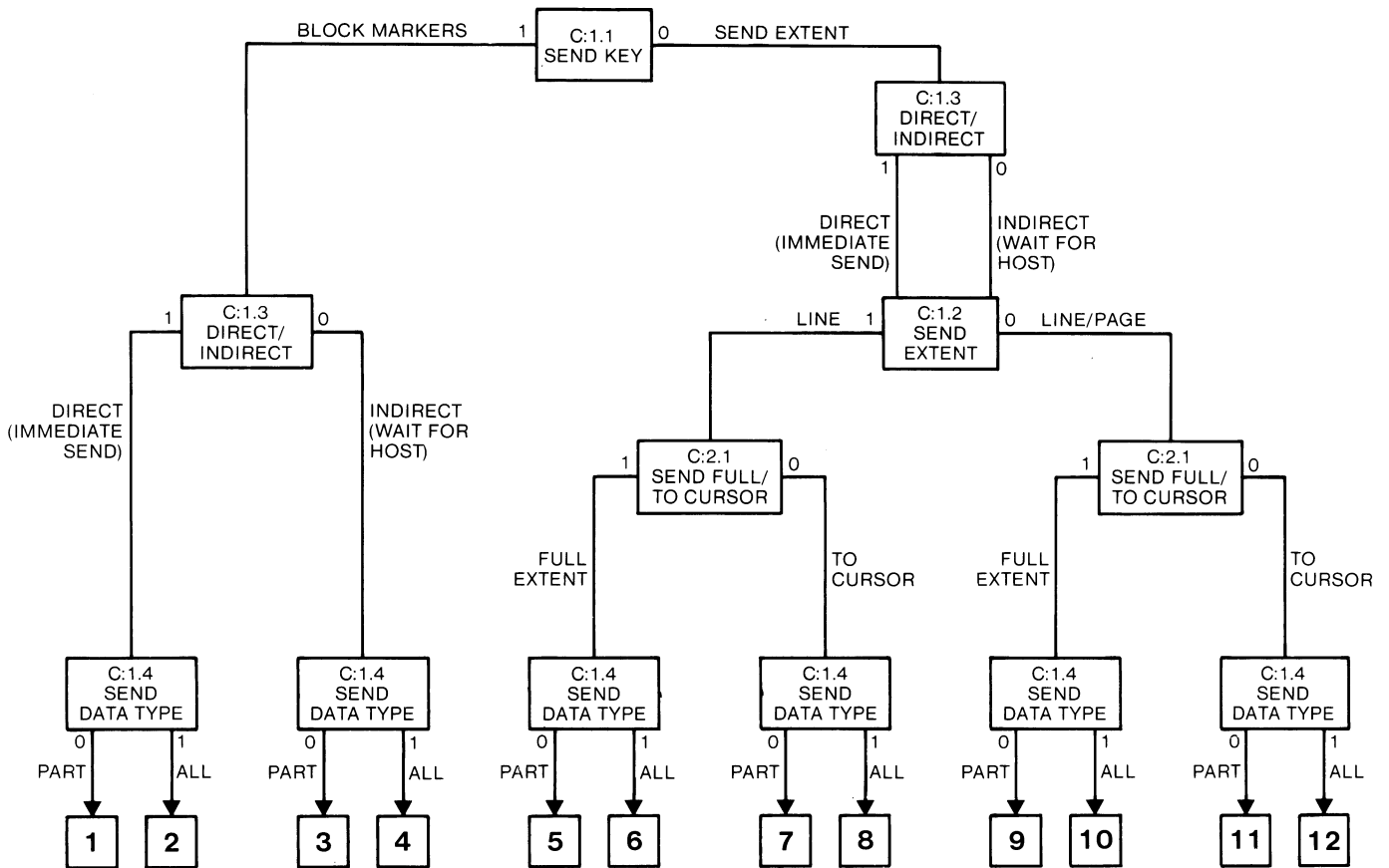

**BLOCK SEND POSSIBILITIES**

1. Press ENTER/PRINT to immediately block send unprotected data between previous block marker and current cursor position. A new block marker is automatically inserted at the current cursor position.
2. Press ENTER/PRINT to immediately block send all data.
3. Press ENTER/PRINT to send a code to the host, indicating that a block of unprotected data is ready for transmission. This data is between the previous block marker and the current cursor position. A new block marker is automatically inserted at the current cursor position upon receipt of a send command from the host.
4. Press ENTER/PRINT to send a code to the host, indicating that a block of all data is ready for transmission.
5. Press ENTER/PRINT or RETURN to send all unprotected data on the line where the cursor lies.
6. Press ENTER/PRINT or RETURN to send all data on the line where the cursor lies.
7. Press ENTER/PRINT or RETURN to send unprotected data from the start of the line containing the cursor, up to the current cursor position.
8. Press ENTER/PRINT or RETURN to send all data from the start of the line containing the cursor, up to the current cursor position.
9. Press ENTER/PRINT to send all unprotected data on the active page, indicated by the cursor.
10. Press ENTER/PRINT to send all data on the active page, indicated by the cursor.
11. Press ENTER/PRINT to send unprotected data from the start of the active page, indicated by the cursor, up to the current cursor position.
12. Press ENTER/PRINT to send all data from the start of the active page, indicated by the cursor, up to the current cursor position.

**Fig. 13 Block Mode Switch Combinations**

## 7. BLOCK MODE

### 7.1 INTRODUCTION

In the Block Mode all characters that are typed on the keyboard are stored in the screen map memory until sent out (directly or indirectly as required) by use of the [ENTER] or [CR] keys. The Block Mode contains commands for Send Line, Send Page and Send Partial Page. Also associated with the Block Mode are the Local Editing and Format Modes. The Block Mode facilitates editing of the screen contents, thus the operator can ensure that all data is correct before transmission. In the Format Mode a format can be set to be protected and not sent out during Block transmission. Use of the Block Mode together with the Format Mode minimises the amount of transmitted data, and is therefore very economical in terms of transmission line time. The Block mode is based on the DEC VT132 concept.

### 7.2 SWITCH SETTINGS

The switch settings required to achieve the desired extent of data transmitted in Block Mode are shown in Fig. 12. When the Send Key Switch C:1.1 is set to 1, all data between block markers will be sent. A new block marker is automatically inserted when a send command is received. The position of each block marker is determined by the operator, who must define the positions by inserting block marker symbols with the cursor.

If alternatively Switch C:1.1 is set to 0, Switch C:1.2 then determines the extent of data to be sent in conjunction with Switch C:2.1. Depending on these settings, data will be sent either from the start of a page or line up to the current cursor position, or complete page or line data will be transmitted.

### 7.3 BLOCK MARKERS

Send Block is initiated by pressing [ENTER]. A block marker is stored in the appropriate position in the page memory and also displayed at the current cursor position. Then the terminal searches backwards for the previous block marker. If one is found, all the data between the two block markers is sent with CR codes inserted at the end of each line on the screen. If no previous block marker is found, the Send Block operation starts at the Home position. At the end of the Send Block function an end of block marker is sent and a visible block marker is displayed on the screen.

Note that while sending, the terminal ignores data received from the host, although the first 13 characters input at the keyboard will be processed on completion of the Send operation.

### 7.4 FORMAT MODE

When the terminal is operating in the Format Mode, the data on the screen may consist of two types - protected and unprotected. The difference between the two is normally shown by using a different video attribute for each, for example the unprotected data may be displayed with bold intensity whilst the protected data has normal intensity.

Protected data cannot be overwritten by the terminal operator and the cursor cannot be positioned on any protected character. Each group of protected or unprotected characters is known as a field. Thus the host may send a series of questions as a series of protected fields, with unprotected fields in between where the terminal operator would insert answers.

The Format Mode is supported by a number of field-oriented facilities:

- (a) Clearing all or some (specified) protected or unprotected fields on the screen.
- (b) Tabulating by fields instead of by fixed tab stops.
- (c) Transmission of unprotected data only to the host.

Entry to and exit from the Format Mode, and user of the field-oriented facilities is normally controlled by the host, sending control commands.

The user may select whether to send all data or only unprotected data when in the Format Mode. When sending data in the Format Mode, each time a protected/unprotected field boundary is crossed a Record Separator (RS) character is transmitted.





## 8. KEYBOARD

### 8.1 GENERAL

The primary purpose of the keyboard is for the operator to send coded data to the host. The keyboard is designed to produce all the 128 codes specified in the ASCII character set (see Appendix 1). These codes may be produced either by pressing one key on its own, or in conjunction with one or two modifier keys (which modify the basic code produced by the single key to another code). Alternative national keyboard styles are also available (see Appendix 1).

When the terminal is in a Set-up Mode, the keyboard is used to set up the basic operating parameters of the terminal, and to control the functions of the terminal and its communication lines.

As shown in Fig. 14, the keyboard may be divided into five functional areas, as follows.

The **Alphanumeric Key Pad** which has the usual typewriter-style key array, but includes some specially assigned (dedicated function) keys. Two

further dedicated function keys, SET-UP and BREAK, are located in the separate group of programmable function keys above the alphanumeric pad.

The **Editing Block**, containing cursor control and editing function keys.

The **Numeric Block**, a calculator-style array which contains duplicates of some character keys associated with numerical entry.

The **Program Function Keys**, a set of four keys in the top row of the numeric block, labelled PF1 to PF4.

The **User Definable Function Keys**, a set of twelve keys in the top row of the keyboard, labelled F1 to F12. There are also four assignable LED indicators located between keys F3 and F4.

When Auto-Repeat is enabled all keys, except [SET-UP], [BREAK], [ESCAPE], [ALPHA-TAB], [RETURN], [NO SCROLL] and [ENTER] will repeat.

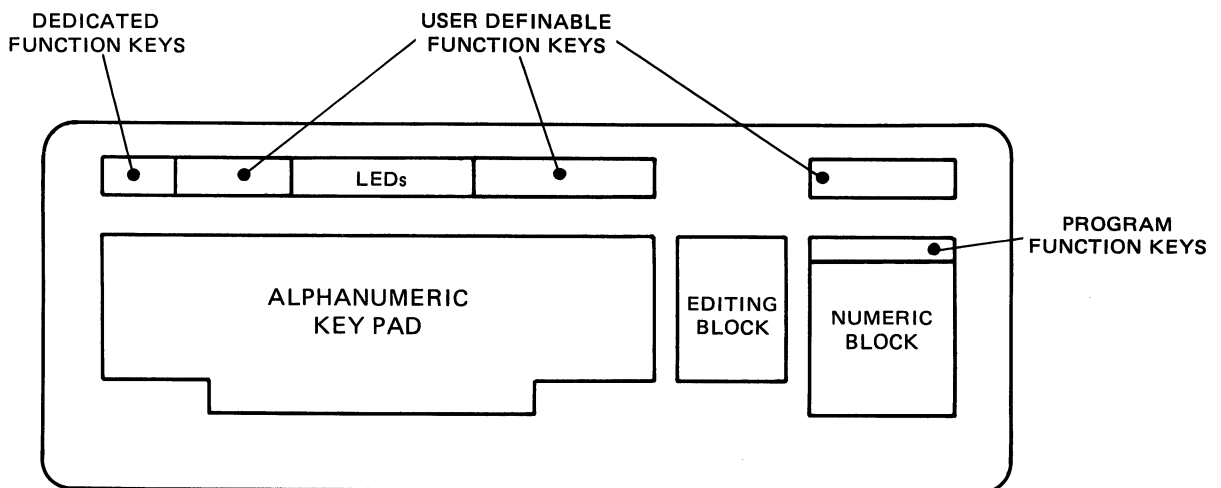

Fig.14 Keyboard Functional Areas

## 8.2 ALPHANUMERIC KEY PAD

The alphanumeric key pad is similar in layout to a conventional typewriter keyboard, and consists of character, modifier and dedicated function keys. The effects obtained by pressing the keys depend on the current mode of terminal operation.

### 8.2.1 CHARACTER KEYS

During On-line and Off-line operation, each of the character keys (shown in Fig. 15) will produce a displayable character or send the corresponding ASCII code according to its keytop legend when it is depressed. The basic character code is modified when a key is depressed at the same time as one of the modifier keys [CONTROL], [SHIFT], or [CAPS LOCK]. The various national versions, together with their special characters and codes, are shown in Appendix 1.

### 8.2.2 MODIFIER KEYS

**CONTROL** - Simultaneous depression of the [CTRL] key and a character key (whether unmodified or modified by [SHIFT] or [CAPS LOCK]) will generate an ASCII code representing a control character. The generated ASCII code is dependent on the fact that that when [CTRL] is pressed together with any

character key, only the lowest 5 bits for the character in question will be used. See Appendix 4 for further details.

**SHIFT** - Both [SHIFT] keys have the same effect, and when either of them is pressed in conjunction with a character key a different ASCII code will be produced by that key. The [SPACE BAR] is not affected by the [SHIFT] keys.

For example depression of the A-key generates an "a", or an "A" if operated with [SHIFT] or [CAPS LOCK] depressed. The numeric key pad is not affected by [SHIFT] except for the [PRINT/ENTER] key (refer to Section 8.4 for further details).

Simultaneous depression of either [SHIFT] key will produce the upper case character defined on the keytop or the top character on keytops with double legends.

**CAPS LOCK** - This has the same effect as the [SHIFT] keys but operates on letter keys only, so that the top row of character keys (mainly numbers) are not affected. The LED at the bottom right hand corner of the [CAPS LOCK] key is lit to remind the operator that the key is locked down, i.e. no lower case letters can be typed. The key is unlocked by pressing it a second time.

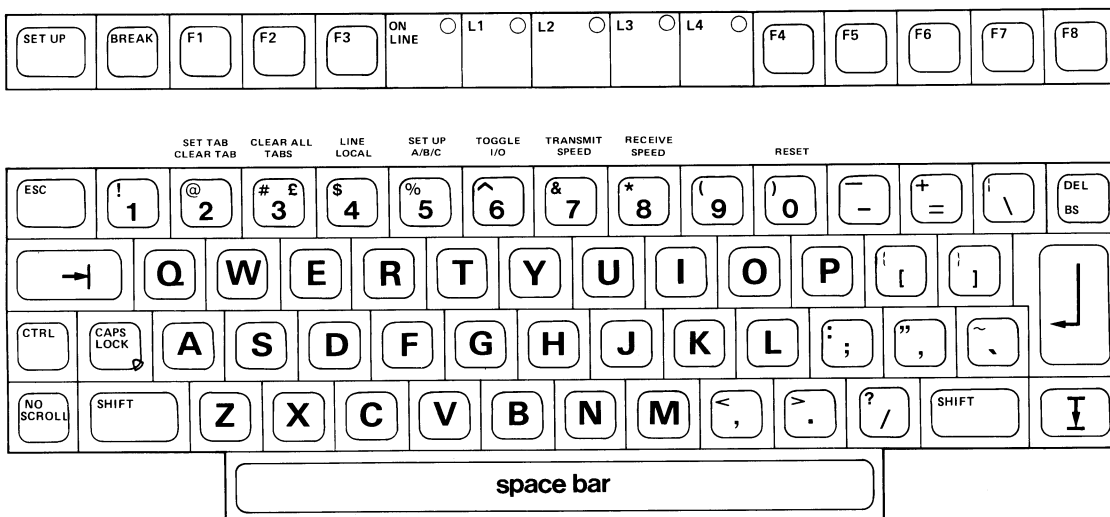

Fig. 15 Alphanumeric Key Pad

### 8.2.3 DEDICATED FUNCTION KEYS

#### SET-UP

Used for entering and exiting the Set-up Mode. Entering the Set-up Mode when Auto-protocol is selected causes the terminal to also enter the Busy state, so that XOFF is transmitted or pin 19 in the interface is pulled low. Upon exit from the Set-up Mode, the terminal enters the Ready state, transmitting XON or setting pin 19 high.

Entering or exiting the Set-up Mode unlocks any "lock states", keyboard lock, etc. Thus, the [SET-UP] key itself is not affected by "keyboard lock" functions. [SHIFT] and [CTRL] have no effect on normal operation in the Set-up A Mode. [CTRL] + [SET-UP] in the Set-up A Mode has a specific function for customization, see Section 10, Custom Mode.

#### BREAK

This key forces the I/O transmission line to the space state as follows.

[BREAK]: 0.233 sec.  
 [SHIFT] + [BREAK]: 3.5 sec. (Pin 19 goes low for 3.5 sec.).  
 [CTRL] + [BREAK]: Transmits the answerback message, does not affect the transmission line.

#### ESCAPE

Shifted or unshifted, depression of this key always produces the ASCII escape code Hex 1B.

#### DEL/BS

Depends on the Switch B:2.3 setting in Set-up B, see Section 9.5.1. Either gives Delete when Unshifted and Backspace when Shifted or vice versa.

### 8.2.4 TRANSMITTED CODES

Key	Unshifted	Shifted	Control
ESC	1B (ESC)	1B (ESC)	1B
TAB	09 (HT)	09 (HT)	09
BS/DEL(*)	08 (BS)	7E (DEL)	08
BS/DEL(*)	7E (DEL)	08 (BS)	08

**Note:** That the desired action by the above keys will take place only when the appropriate codes have been received by the terminal - either by echo from the host or by local echo (when in Local or Block Mode).

#### RETURN

Shifted or unshifted, this key causes the cursor to move to the first position on the next lower line.

#### NO SCROLL

Shifted or un-shifted, alternately starts and stops scrolling. If Auto protocol is selected, the XOFF or Busy state is entered upon receipt of the next CR, LF, VT, FF, Next Line or Index Commands, then the screen is "frozen". The next depression causes scrolling to be continued and XON, or the Ready state, is entered. If Auto protocol disable is selected the function is as above but with the difference that XOFF/XON and Ready/Busy are not executed. When the I/O buffer is filled to its XOFF/Busy level the scrolling is continued, and at the emergency buffer level the terminal automatically takes on the "jump scroll" mode.

#### CTRL + NO SCROLL

This combination toggles the terminal between smooth and jump scroll; no codes are transmitted.

#### PRINT/ENTER

**Unshifted:** If the terminal is interactive, this gives CR. In Block Mode initiates the Send operation (refer to Section 9.6, Switch Group C.1).

**Shifted:** Initiates a Print operation (see Section 9.6, Set-up C, Switch Group C.5).

**CTRL + PRINT/ENTER** enters or exits the Auto-Print Mode.

**CTRL + SHIFT + PRINT/ENTER** prints the visible screen page (Screen Dump).

#### TAB

This key provides horizontal tabulation.

(\*) Selectable in Set-up B Mode.

### 8.3 EDITING BLOCK

This block of 12 keys includes four cursor control keys in an "inverted T" layout, a pair of tabulation forward and backward keys, line and character insertion and deletion control keys, a [HOME] key and an [ERASE] key.

**Note:** The following key function definitions may be altered either by Custom programming or by the Edit Keys Set/Reset function. Refer to Section 10.6.1 for further details of possible alterations.

#### 8.3.1 CURSOR KEYS

**Unshifted:** Used to move the cursor left, right, up and down. Each key depression moves the cursor one step. The cursor cannot be moved outside the page-defined regions.

**Shifted:** [CURSOR LEFT]/[CURSOR RIGHT], same as unshifted above. In Flip Page Mode [CURSOR DOWN] advances the displayed page to the next page in memory; [CURSOR UP] backs the displayed page to the previous one in memory.

**CONTROL:** The [CTRL] modifier key on the alphanumeric key pad will have no effect on the cursor control keys.

**Note:** If the terminal is set to Cursor Keys Application Mode, the codes from these keys are altered (in ANSI Mode only), in accordance with the table in Section 8.3.2, Transmitted Codes.

#### TABULATION FORWARD

This key has the same function as the [TABULATION] key on the alphanumeric key pad.

#### TABULATION BACKWARD

This key is used to move the cursor to tabulation positions to the left of its current position.

The [TABULATION] keys are not affected by the modifier keys [CONTROL], [SHIFT] or [CAPS LOCK].

#### HOME

**Unshifted:** Moves the cursor to the home position on the currently displayed page.

**Shifted:** Moves the cursor to the home position and clears the active page to spaces with all attributes off - except protected fields when Format Mode is in operation (depending on the setting of Erasure Mode, see Sections 18.1 and 18.2). The currently assigned attributes will still be in effect when characters are entered.

#### INSERT LINE

At each key depression a new line is inserted at the line denoted by the cursor. The lines below are moved down one line, and the last line on the active page or within the region is lost. The cursor is moved to the first position on the new line.

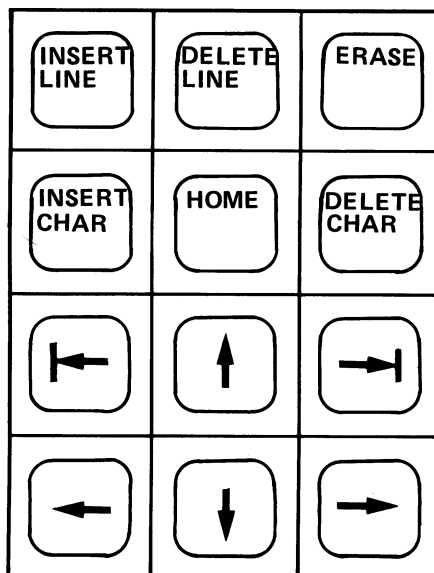

Fig. 16 Editing Block



## INSERT CHARACTER

When this key is depressed the terminal enters the Insertion Mode, i.e. characters to the right of the cursor are shifted right one position for each new character entered. The last character on the line is lost. A second depression of the [INSERT CHARACTER] key causes the terminal to exit from the Insertion Mode. The Status Line can be used to show which Mode is in operation.

## DELETE LINE

Each depression causes the line denoted by the cursor to be deleted, and the cursor is moved to the first position on the line which has been moved up to fill the "gap". The lines below the deleted line on the same page and/or within the region are moved up one line.

### 8.3.2 TRANSMITTED CODES

Key	Unshifted		Shifted		Cursor Keys Application (Unshifted) ANSI
	ANSI	CUSTOM DEFAULT	ANSI	CUSTOM DEFAULT	
CURSOR UP	CSI A	ESC A	CSI V	ESC v	ESC OA
CURSOR DOWN	CSI B	ESC B	CSI U	ESC u	ESC OB
CURSOR RIGHT	CSI C	ESC C	-	-	ESC OC
CURSOR LEFT	CSI D	ESC D	-	-	ESC OD
TAB	HT	HT	HT	HT	
BACK TAB	CSI Z	ESC c	CSI Z	ESC c	
HOME	CSI H	ESC H	CSI X	ESC L	
<b>INSERT:</b>					
LINE	CSI L	ESC T	-	-	
CHAR	CSI 4h/l	ESC !/CAN	-	-	
<b>DELETE:</b>					
LINE	CSI M	ESC U	-	-	
CHAR	CSI P	ESC "	-	-	
ERASE	CSI K	ESC K	CSI J	ESC J	

**Note:** If the terminal has been customized the keys above will transmit the custom defined codes for the corresponding function. Naturally if the keyboard has been specifically redesigned the key codes will be in accordance with their new functions. The Cursor Keys Application is not applicable for shifted ANSI or Custom Mode.

**Note:** That the desired action by the above keys will take place only when the appropriate codes have been received by the terminal - either by echo from the host or by local echo (When in Local or Block Mode).

## DELETE CHARACTER

Each depression of this key causes the character at the active cursor position to be deleted. Characters to the right of the deleted character are moved one position to the left.

The [INSERT] and [DELETE] keys are not affected by [SHIFT] unless the terminal has been customized

## ERASE

**Unshifted:** This key will Erase End Of Line, whereby the active cursor position and characters to the right of the cursor as far as the end of the line will be replaced by spaces.

**Shift:** Erase End Of Page, in this case the active cursor position and characters to the right of and below the cursor will be replaced by spaces.

**8.4 NUMERIC BLOCK**

The numeric keypad may be used either in the Keypad Numeric Mode to send numeric data, or in the Keypad Application Mode for application-dependent purposes. Note that the top row of keys, labelled PF1 to PF4 are Program Function Keys, discussed in Section 8.5.1.

**8.4.1 KEYPAD NUMERIC MODE**

The keytop legends on these 14 keys show its normal function in the Keypad Numeric Mode as a calculator-style key pad, which allows the rapid entry of numeric data, and may be more convenient to use than the row of numerical keys on the alpha-numeric key pad.

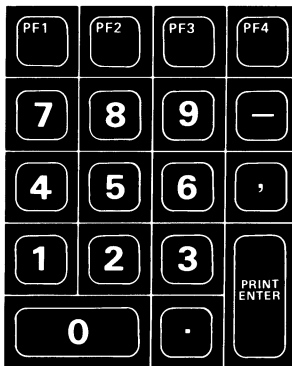

**Fig.17 Numeric Block - Numeric Mode**

**8.5 FUNCTION KEYS**

This Section includes both the separate set of program function keys in the top row of the numeric block, labelled PF1 to PF4, and twelve user definable function keys labelled F1 to F12 located along the top row of the keyboard.

**8.4.2 KEYPAD APPLICATION MODE**

When the Keypad Application Mode is entered (refer to Section 17.6), these keys transmit unique escape sequences. Note that the [PRINT/ENTER] key is used in conjunction with the [CONTROL] and [SHIFT] keys (see Section 8.2.3).

The Keyboard Application Mode escape sequences for the numeric block are shown in Fig. 18(a) (ANSI) and Fig. 18(b) (Custom Default).

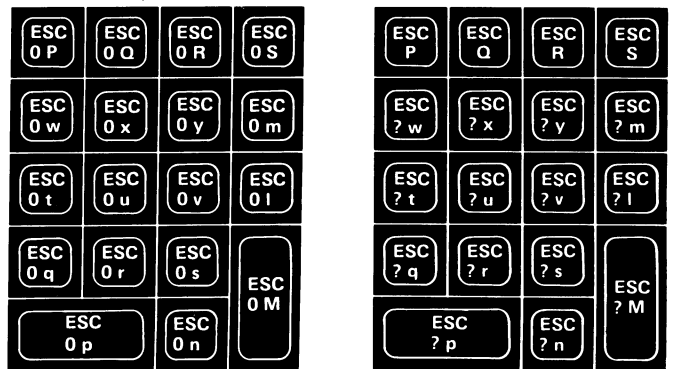

**(a) ANSI**

**(b) Custom Default**

**Fig.18 Numeric Block - Application Mode**

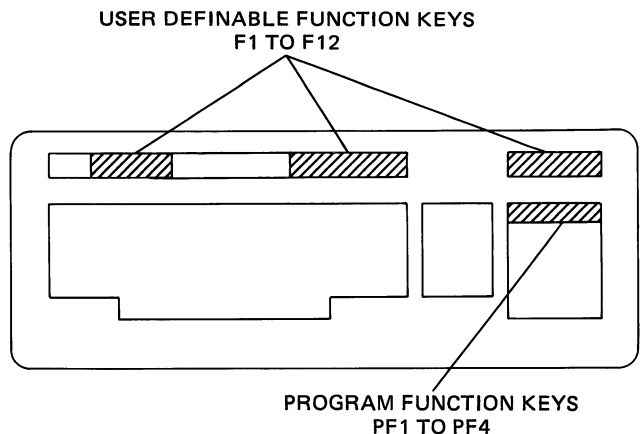

**Fig. 19 Function Keys**

### 8.5.1 PROGRAM FUNCTION KEYS

The program function keys are programmed to transmit particular code sequences when depressed.

#### ANSI Mode

##### - Unshifted

Key	Code	Hex
PF1	ESC O P	1B 4F 50
PF2	ESC O Q	1B 4F 51
PF3	ESC O R	1B 4F 52
PF4	ESC O S	1B 4F 53

##### - Shifted

Key	Code	Hex
PF1	ESC P	1B 50
PF2	ESC Q	1B 51
PF3	ESC R	1B 52
PF4	ESC S	1B 53

#### Custom Mode

##### - Unshifted and Shifted

Key	Code	Hex
PF1	ESC P	1B 50
PF2	ESC Q	1B 51
PF3	ESC R	1B 52
PF4	ESC S	1B 53

### 8.5.2 USER DEFINABLE FUNCTION KEYS

The 12 function keys are programmed according to the desired application to transmit particular codes or code sequences when depressed. These codes or sequences can be altered by Custom programming; refer to the Set-up Mode B Section 9.5.

The transmitted codes are independent of the selected Command Mode (ANSI or Custom).

Customization of these 12 keys gives a possible maximum of 36 different programmable functions (Unshifted, Shifted and with Control), with up to 63 bytes assignable to each function key. The total number of bytes assigned cannot however exceed 221.

If the host is used to assign functions to the function keys, these functions will then apply to the terminal and also be transmitted as data to the host. Only F1 to F12 Unshifted and Shifted (a total of 24 functions) can be assigned by the host.

The keyboard can be used to assign all 36 possible key combinations, and in this case the operator can choose whether to restrict the functions to local terminal use only, or have them sent to the host.

Key	Unshifted	Shifted	Ctrl
F1	ESC 1	ESC a	-
F2	ESC 2	ESC b	-
F3	ESC 3	ESC c	-
F4	ESC 4	ESC d	-
F5	ESC 5	ESC e	-
F6	ESC 6	ESC f	-
F7	ESC 7	ESC g	-
F8	ESC 8	ESC h	-
F9	ESC 9	ESC i	-
F10	ESC :	ESC j	-
F11	ESC ;	ESC k	-
F12	ESC <	ESC l	-

Hex: 1B and 31-3C

Hex: 1B and 61-6C

### 8.6 PROGRAMMABLE LEDs

A set of five LEDs are arranged along the top of the keyboard. The four right-most LEDs (labelled L1 to L4) are under application control, as detailed in Section 17. The left-most LED, labelled ON-LINE, gives the following indications.

**UNLIT:** Terminal Off-line.

**LIT:** Terminal On-Line.

**FLASH:** Busy Status has been given to the host.

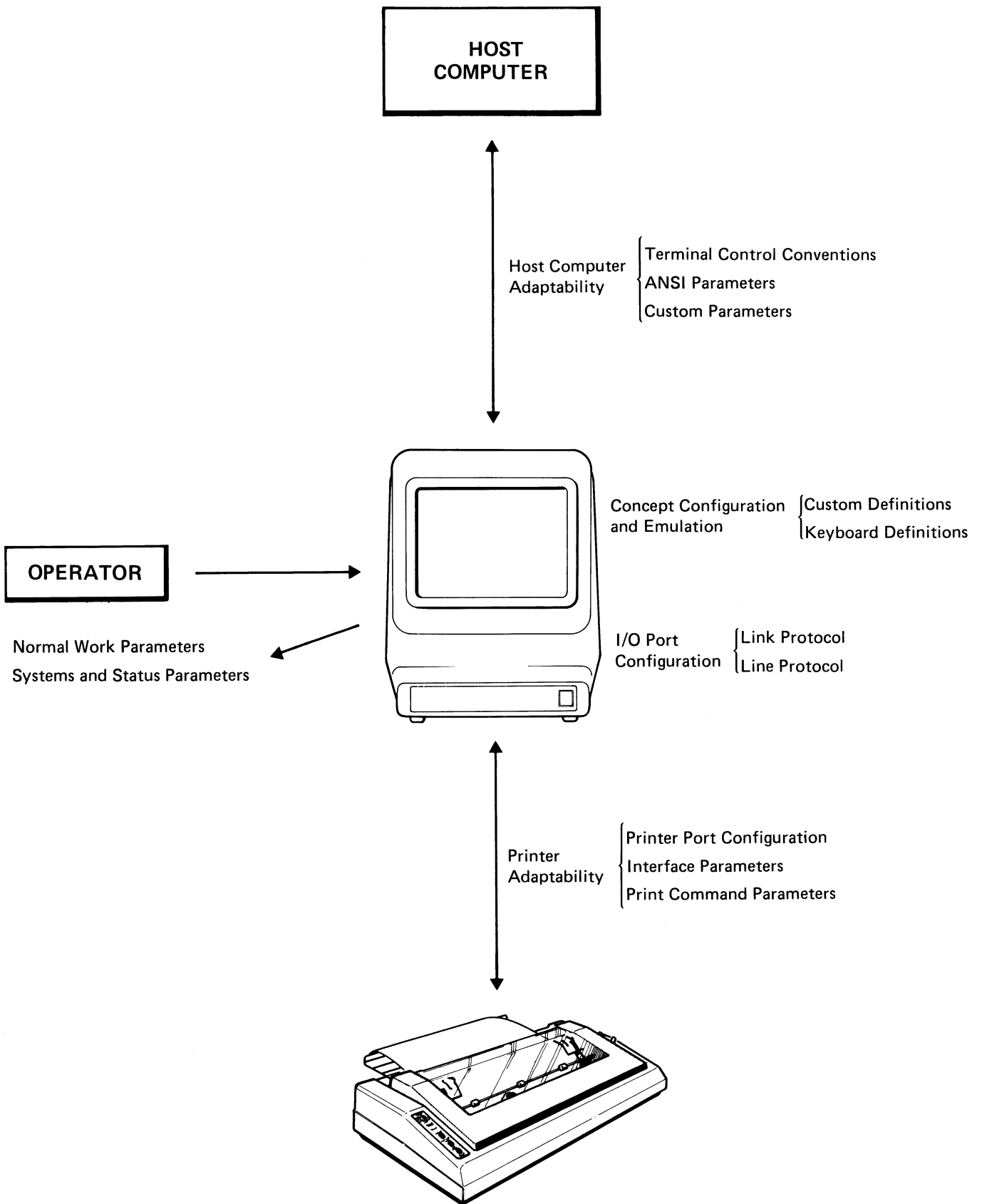

**Fig.20 Set-up Mode Functions**

## 9. SET-UP MODE

### 9.1 SET-UP MODE STRUCTURE

The Set-Up Mode is used to configure the operating parameters in the terminal system. This Mode contains two different sets of menus - Set-up A, B, C and Custom Mode Set-up 1, 2, 3, 4. Each menu contains a number of "soft switches" that can be changed by the operator (and in some cases also by the host computer). The vast range of possibilities that the Set-up Mode offers can be divided into the following logical sections.

#### 9.1.1 OPERATOR FLEXIBILITY

Terminal Operator flexibility can be divided into two subsections - Normal work parameters, and Systems and Status parameters.

Set-up Menus A and B contain **Normal work parameters** which enable the operator to tailor the functions of the terminal so that it is easy and convenient to use in the specific desired application.

**Systems and Status parameters** can be easily obtained via Set-up Menu C and are primarily intended for systems analysis and debugging.

#### 9.1.2 COMPUTER FLEXIBILITY

Computer flexibility covers the headings Printer Adaptability, Host Computer Adaptability, Concept Configuration and Emulation, and I/O Port Configuration.

**Printer Adaptability** includes Printer Port Configuration, Interface parameters and Printer Command parameters.

**Host Computer Adaptability** includes Terminal Control conventions as well as ANSI parameter settings and/or Custom parameter settings.

**Concept Configuration and Emulation** includes Custom definitions and Keyboard definitions.

**I/O Port Configuration** defines the input/output interface of the terminal, such as baud rate, line protocol, link protocol, etc.

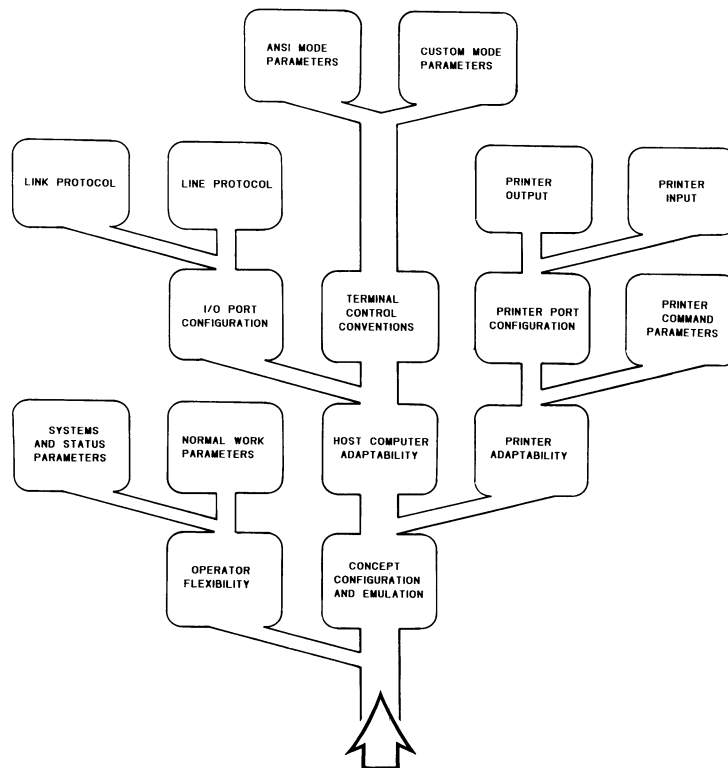

Fig.21 Set-up Mode Structure



9.2 SET-UP MODES A,B AND C

9.2.1 INTRODUCTION

The terminal does not employ hardware switches to set its operational parameters. Instead the user confirms or changes the parameters whilst in the Set-up Mode by means of software controlled switches which are displayed with their current settings on the screen.

All the parameter values are stored in a nonvolatile EAROM, so that data will be preserved even when the power is off. This ensures that each time the terminal is switched on, the same set of initial values will be present. These values may however be changed by the operator, either:

- (a) Temporarily (at most, until the terminal is next switched off), in which case the values in EAROM remain unchanged and will be used when the terminal is next switched on or reset.
- or (b) Permanently, by replacing the EAROM values with the temporary parameters, thereby changing the switch-on state of the terminal.

Note that some parameters can be changed remotely by the host, but these changes are only in the temporary category.

The user may also at any time reset all the parameters to either their power up or factory settings, or may just reset the horizontal tabs.

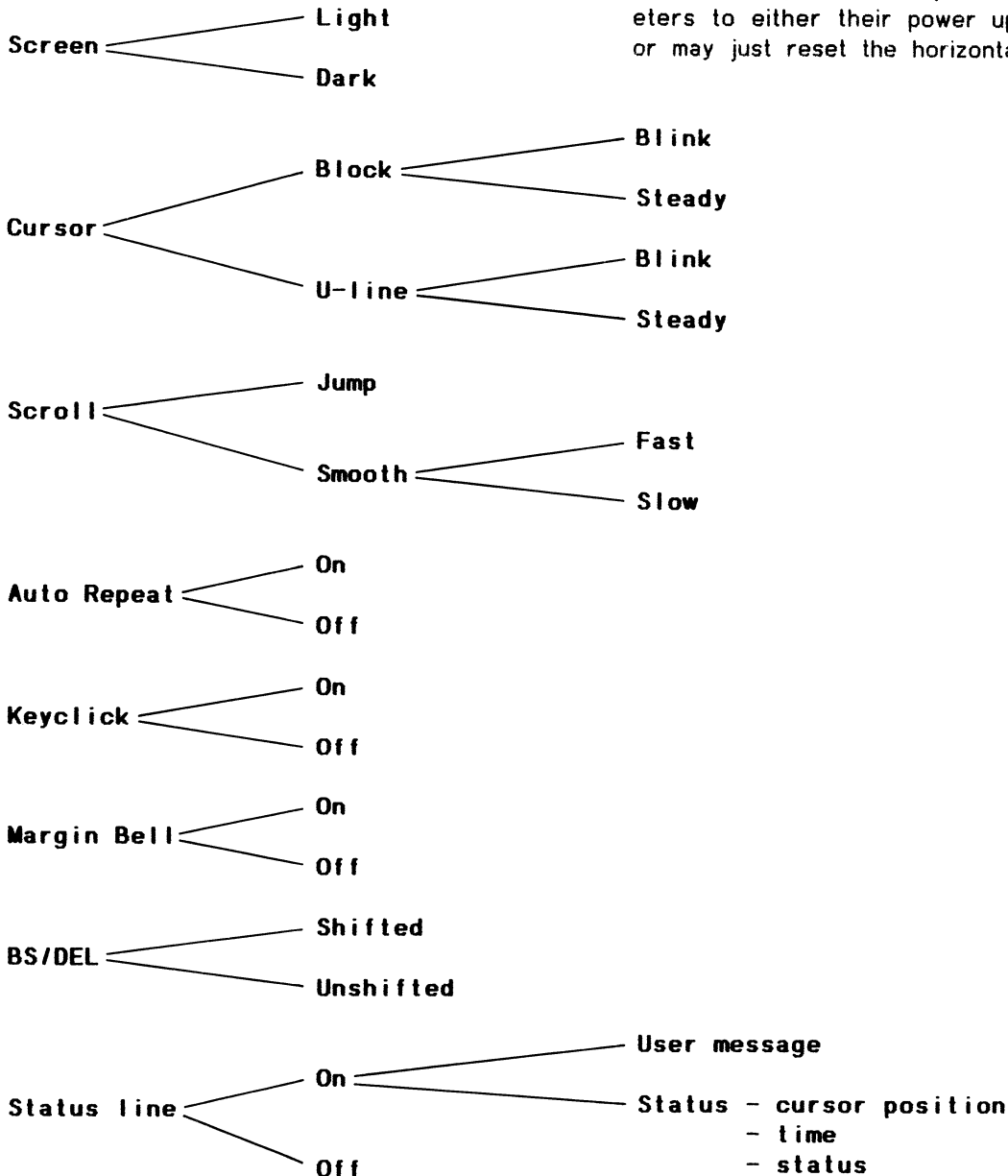

Fig. 22 Operator Selections in Set-Up Modes

### 9.2.2 GENERAL FEATURES

Set-up Mode is entered by depressing the [SET UP] key on the keyboard. Initially the Set-up A menu is displayed.

At any time whilst in the Set-up Mode the operator may adjust the screen brightness, switch between On-Line and Local operation, change or recall the operating parameter values held in EAROM or reset the terminal to its initial state. Appendix 3 summarises the general features.

Any Set-up Mode (A, B or C) may be exited at any time by pressing the [SET UP] key again. On exit from a Set-up Mode the parameter values are preserved and will be displayed again whenever Set-up Mode is re-entered (except after power off).

### 9.2.3 SET-UP DISPLAYS

All the current operational parameter values are shown on three Set-up Mode display menu pages, known as Set-up A, B and C. On initial entry to the Set-up Mode, the Set-up A display is shown.

Changing between Set-up A, B and C menu pages is done in a fixed sequence, A B C A etc., by depression of the 5 key.

### 9.2.4 BRIGHTNESS

At any time whilst in the Set-up Mode, the screen brightness may be increased or decreased over a range of 32 different brightness levels by means of the [CURSOR UP]/[CURSOR DOWN] control keys. Momentarily depressing the [CURSOR UP] key increases the brightness by one step. If the key is held depressed the brightness will continue to increase to its maximum, providing that Auto Repeat is enabled. Conversely depressing [CURSOR DOWN] reduces the intensity until a minimum is reached.

### 9.2.5 ON-LINE/OFF-LINE OPERATION

The Set-up Mode must be entered to change the communication mode. The current state is indicated by a keyboard LED (the ON-LINE LED is lit when the terminal is On-line in Interactive or Block Mode, and is extinguished when the terminal is Off-line). The communication state is changed by depressing the 4 key (which has the words LINE/ LOCAL above it) at any time whilst in the Set-up Mode; repeated depressions toggle between On-line, Block Mode and Off-line.

### 9.2.6 CURSOR MOVEMENT

When changing operational parameters using the Set-up Mode, the parameter to be changed should be indicated by the cursor. The cursor can be moved horizontally by means of the [SPACE], [CURSOR LEFT]/[CURSOR RIGHT], [TAB] and [RETURN] keys.

### 9.2.7 SAVE SET-UP PARAMETERS

After changing any of the operational parameters in Set-up A, B or C, the user may make them permanent by typing [SHIFT] + S. The screen will display the message "Saving new configuration: PLEASE WAIT" for about 10 seconds and then return to the Set-up display. This Save operation stores the new parameters in the EAROM for use at power up or after a reset.

### 9.2.8 RECALL SET-UP FEATURES

The parameters that were most recently stored in the EAROM may be used to replace the currently displayed (temporary) parameters by typing [SHIFT] + R. The screen will go blank for about 3 seconds, then a double tone will sound and the Set-up A display will appear. If the terminal cannot verify the data stored in the EAROM, the terminal will sound the bell five times. If this happens the operator must verify and re-establish each of the parameters and then replace the corrupt data in EAROM by performing a Save operation, as detailed in Section 9.2.7.

**9.3 RESETTING THE TERMINAL**

**9.3.1 POWER UP STATUS**

The terminal may be reset to its power-up status without switching off by depressing the 0 (zero) key on the main keyboard (the word RESET is printed above the key). The terminal performs a self-test operation and then adopts the operational parameters stored in the EAROM, as it would when switched on.

**9.3.2 FACTORY SET-UP VALUES**

All parameter values in the Set-up A, B and C Modes may be reset to their delivery status (production settings) by typing [SHIFT] + D. These default settings are underlined in the appropriate Set Up Switch summaries and in Appendix 3, the Set-up Mode summary. [SHIFT] + D always returns the Set-up A screen display.

**9.3.3 SET TABS TO DELIVERY VALUES**

The default positions of the tab stops (9th column and every subsequent 8th column) as set during production may be regained by typing [SHIFT] + T.

**9.4 SET-UP A**

On entry to Set-up A the display will appear similar to that shown in Fig.23. It shows each currently selected tab position as a T above the scale at the bottom of the screen. The Set-up A parameters are summarised in Appendix 3.

**9.4.2 CLEARING ALL TABS**

The user may clear every tab by depressing the 3 key with the cursor in any position.

**9.4.3 SET MARGIN BELL POSITION**

The margin bell position is indicated on the row of numbers at the bottom of the screen by a flashing column number on the scale at the bottom of the screen. The default (factory set) position is at column 73. If a different margin bell position is required move the cursor to the position where the margin bell will be required to sound, and then press [SHIFT] + B to set the position.

**9.4.1 CHANGING TABS**

To insert or delete any tab, place the cursor at the required point over the scale and press the 2 key. If the cursor was positioned over a T, that tab will now be deleted. If the cursor was not positioned over a previous tab, then one will be inserted and a T will appear at the cursor position. In both cases the cursor remains at the same position (it does not automatically move right as it would with normal character entry).

Note that the factory settings for tabs can be regained by typing [SHIFT] + T.

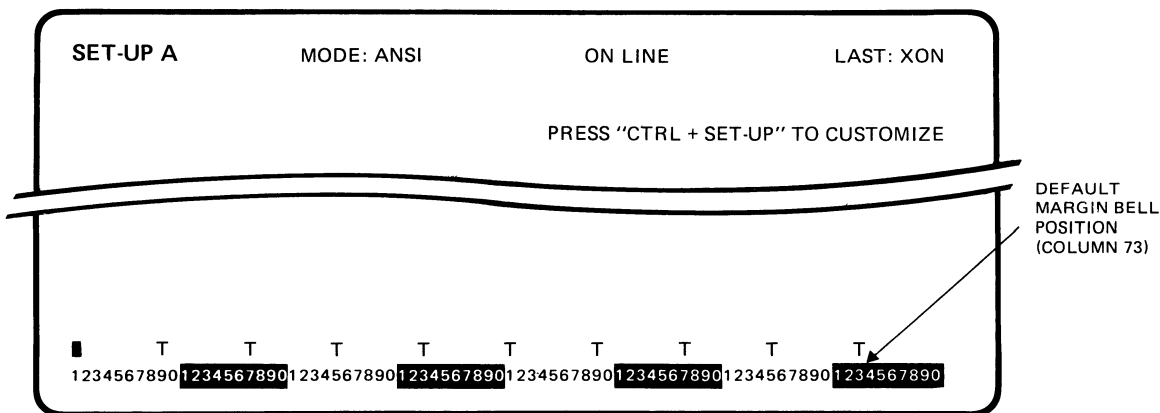

Fig.23 Set-up A Display

## 9.5 SET UP B

The Set-up B display (Fig. 24) shows six groups of four switches at the bottom left and two speeds (transmit and receive) at the bottom right.

Each switch has two positions, 0 and 1. To select a switch, move the cursor until it is above the required switch, when its current function will be shown underlined. To change the switch status and function, depress the 6 key. Another depression of the 6 key will toggle the switch back again. The individual switch functions are described below and summarised in Appendix 3.

The two speed controls are cyclic in operation, see the description below.

Set-up B is also used to define an answerback message to be used when the terminal is interrogated by the host, as well as the user definable function keys.

### Answerback Message

Set-up B can be used to define the answerback message which is to be sent by the terminal in response to an ENQ code (Hex 05) from the host or by the operator typing [CTRL] + [BREAK]. To define the message depress the [SHIFT] + A keys simultaneously. The terminal will respond by displaying "A = " just above the switches on the screen. The user should then enter the required answerback message in the following format:

<delimiter> message of up to 20 chars. <delimiter>

where <delimiter> can be any character, as decided by the user, and the message can use any other characters (except the delimiter character) including control characters. The second occurrence of the delimiter character terminates the message.

If the limit of 20 characters is reached, the second delimiter is generated automatically. Where control characters are used in the message, they are

displayed as an asterisk (\*) followed by the associated control character, both in reverse video, (e.g. SOH = [CTRL] + A is displayed as \*A in reverse video).

The answerback message must be Saved when it has been set up correctly on the screen.

### User Definable Function Keys

#### Keyboard Defined

The twelve function keys F1 to F12 can be user-defined for up to 36 different functions, as each key may be unshifted, shifted or used together with the [CTRL] key. Function key definition is carried out in Set-up Mode B by pressing the appropriate function key on its own, with [SHIFT] or with [CONTROL]. The chosen combination is then shown on the screen, e.g. "F1 + SHIFT = ". Thereafter the desired characters (including control characters) up to a maximum of 63 characters per key (within the total available EAROM bytes) can be entered. The function key is then assigned by pressing [CTRL] + [RETURN] which stores the function in EAROM. If the function key is assigned by [CTRL] + [SHIFT] + [RETURN] the function will be designated as "local only", and appear on the screen but will not be transmitted to the host. Function keys assigned by [CTRL] + [RETURN] are called global function keys as their information is sent to the host.

#### Host Defined

User definable keys F1 to F12 can be defined by the host, either unshifted or shifted, for a total of 24 functions. Once defined the functions can be stored in EAROM (when in Set-up Mode B), by pressing [SHIFT] + S. Refer to Section 25.1 for the appropriate control codes.

Note that the Save Inhibit jumper on the logic board can be used to inhibit the terminal operator from changing the values stored in EAROM.

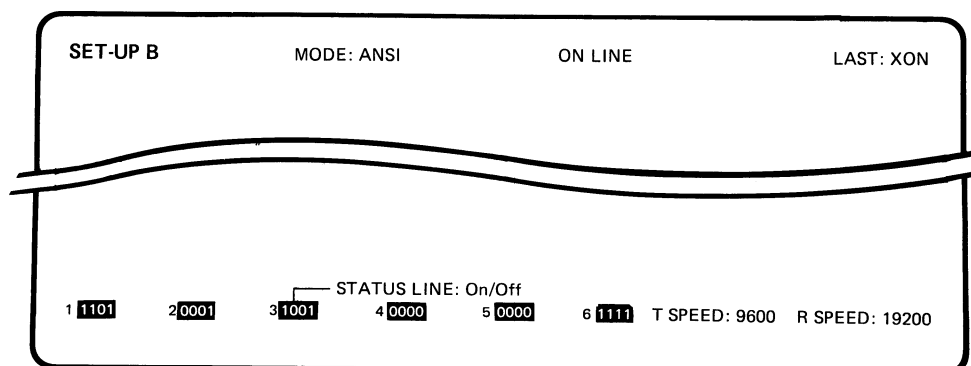

Fig. 24 Set-up B Display

### 9.5.1 SET UP B SWITCHES

**Note:** Factory default settings are underlined.

#### Group 1 Switches:

	1	0
CURSOR:	<u>Enabled</u>	Disabled
CURSOR:	<u>Block</u>	Line
CURSOR:	Steady	<u>Blink</u>
SCREEN		
BACKGROUND:	<u>Reverse</u>	Normal Video

#### Group 2 Switches:

	1	0
SCROLL:	Smooth	<u>Jump</u>
SMOOTH SCROLL		
SPEED:	Fast	<u>Slow</u>
BACKSPACE KEY:	Delete	<u>Backspace</u>
RESERVED:	Enabled	<u>Disabled</u>

#### Group 3 Switches:

	1	0
AUTO REPEAT:	<u>Enabled</u>	Disabled
STATUS LINE:	On	<u>Off</u>
MARGIN BELL:	Enabled	<u>Disabled</u>
KEYCLICK:	<u>Enabled</u>	Disabled

#### Group 4 Switches:

	1	0
AUTO PROTOCOL:	<u>Enabled</u>	Disabled
PROTOCOL:	<u>XON/XOFF</u>	RDY/BUSY
X-ON/X-OFF		
FROM HOST:	<u>Protocol</u>	Data
PRINTER TO		
HOST:	Enabled	<u>Disabled</u>

#### Group 5 Switches:

	1	0
LOCAL ECHO:	Enabled	<u>Disabled</u>
DATA RATE		
TO HOST:	60 cps	<u>Unlimited</u>
DUPLEX:	Half	<u>Full</u>
STOP BITS:	2	<u>1</u>

#### Group 6 Switches:

	1	0
DATA BITS:	<u>8</u>	7
8th DATA BIT:	<u>1 (Mark)</u>	<u>0 (Space)</u>
PARITY SENSE:	Even	<u>Odd</u>
PARITY:	Enabled	<u>Disabled</u>

## Switch Group B.1

### B:1.1 Cursor Enable/Disable

When enabled (Switch = 1, Default) the cursor symbol will be displayed. When disabled (Switch = 0) the cursor symbol will not be displayed.

### B:1.2 Cursor Block/Line

When enabled (Switch = 1, Default) the cursor symbol will be a solid rectangle. When disabled (Switch = 0) the symbol will be a short underline. Cursor underline is only available in Landscape Mode.

### B:1.3 Cursor Steady/Blink

When enabled (Switch = 1, Default) the cursor symbol will not blink - Steady. When disabled (Switch = 0) the cursor symbol will blink.

### B:1.4 Screen Background

When enabled (switch = 1), dark characters will be displayed on a light background. When the switch is set to 0 light characters will be displayed on a dark background.

## Switch Group B.2

### B:2.1 Scroll

Scrolling is the vertical movement of the display to make room for new lines at the top or bottom. When set for Jump Scroll (switch = 0), the display jumps one full character line at a time, but when the host is transmitting a rapid succession of lines to the terminal, jump scrolling may make the display difficult to read. Selecting Smooth Scroll (Switch = 1) limits the vertical movement of text to a steady rate (a line of text moves up two dots at a time, giving several small steps rather than one big jump).

### B:2.2 Smooth Scroll Speed

With smooth scrolling selected, the user can choose between slow (6 lines per second) or fast (12 lines per second) scrolling. When smooth scrolling is to be used, the terminal and the host should be synchronised by selecting the Auto Protocol feature. This will prevent loss of data at high data rates.

### B:2.3 Back Space/Delete Key

When the Switch is set to 0, Back Space is generated from the unshifted [BS/DEL] key. [SHIFT] + [BS/DEL] generates the Delete code. When the Switch is set to 1, the functions are reversed, i.e. the Delete code is generated from the unshifted [BS/DEL] key, and [SHIFT] + [BS/DEL] gives Back Space.

### B:2.4 Unused

## Switch Group B.3

### B:3.1 Auto Repeat

When this feature is enabled (Switch = 1) it allows most key functions to repeat automatically after the key has been depressed for 0.5 sec. Keys which will not Auto Repeat are the [SET UP], [BREAK], [ESCAPE], [NO SCROLL], [ALPHA TAB], [RETURN] and [ENTER] keys, and any other key that is depressed in conjunction with the [CTRL] key.

### B:3.2 Status Line On/Off

When this Switch is set to 1 the Status Line is shown as a separate line at the bottom of the screen.

### B:3.3 Margin Bell

When enabled (Switch = 1) a double beep will sound whenever passing the margin bell position. When the switch is set to 0 the margin bell will not sound.

### B:3.4 Key Click

When the Switch is set to 1 a click will be sounded each time an encoded key is depressed and a code is generated. When the switch is set to 0 the keyclick is disabled.

## Switch Group B.4

### B:4.1 Auto Protocol

Selection of Auto Protocol (Switch = 1) enables the terminal to automatically suspend and restart transmission from the host. This is done either by sending the synchronizing codes XOFF and XON, or by changing the level of the Ready/Busy line (I/O connector pin 19, high = Ready and low = Busy).

When Auto Protocol is enabled, the terminal will send the XOFF code or set the Ready/Busy line low (Busy) in any of the following circumstances:

- (1) When the internal data buffer is half full (128 characters), to prevent loss of data due to the buffer overflowing. A second emergency XOFF is sent when the buffer contents reach 228 characters.
- (2) When the [NO SCROLL] key is depressed and CR and/or LF have been received from the host, to allow the operator time to view the data on the screen.
- (3) During Set-up mode, when the terminal is unable to display incoming data.
- (4) If XON/XOFF protocol has been selected, when [CTRL] + S is typed, since this key combination produces the ASCII code for XOFF.

After the terminal has instructed the host to suspend transmission, the On-line LED will flash until a re-start transmission instruction is sent. The terminal sends the XON code and sets the Ready/Busy lines to High (Ready):

- (1) When the internal buffer empties - below 64 characters.
- (2) When the [NO SCROLL] key has been pressed a second time.
- (3) On exit from the Set-up Mode.
- (4) When [CTRL] + Q is typed, since this key combination produces the ASCII code for XON.

When the Ready/Busy protocol is selected, regardless of whether Auto Protocol is enabled or disabled, the XON and XOFF codes will only be generated by the terminal if the operator types [CTRL] + S and [CTRL] + Q respectively.

### B:4.2 Protocol

When this Switch is set to 0, XON/XOFF protocol is selected. When set to 1, Ready/Busy protocol is selected. Switch B:4.1 determines whether the selected protocol is operational.

### B:4.3 XON/XOFF From Host

When the Switch is set to 1, the terminal accepts and acts upon XON and XOFF control codes sent from the host computer as protocol controlling codes. When the switch is set to 0, the terminal treats these codes as normal data without a protocol meaning.

### B:4.4 Printer to Host

This feature enables printers which have keyboards to communicate directly with the host. When enabled (Switch set to 1), all data received by the terminal at its printer port is passed on to the host, except for XON and XOFF which the printer uses to indicate its status to the terminal. When the Switch is set to 0, all data sent from the printer other than XON and XOFF is ignored.

## Switch Group B.5

### B:5.1 Local Echo

When enabled (Switch = 1) all data sent via the I/O port will be echoed locally (via the terminal) to the display. When disabled (Switch = 0, Default), data will be sent directly out from the I/O port and will not be displayed until the host has echoed the character back to the terminal via the communication link and any parity (if enabled), has been verified.

### B:5.2 Data Rate To Host

When enabled (Switch = 1), this feature limits the data transmission rate to the host to a maximum of approximately 60 characters per second, regardless of Baud Rate. Since the keyboard auto-repeat rate is independently limited to 30 characters per second by the terminal, the limited transmission rate primarily affects automatic transmissions by the terminal, such as transmission of the answer-back message, or programmable function keys. This feature is necessary in installations where the host computer requires that the incoming data rate does not exceed 60 c.p.i.

### B:5.3 Duplex - Half/Full

With this switch set to 0 (Default) the terminal will keep the RTS line in the I/O interface high whenever the terminal is On-Line (Full Duplex). Otherwise, with the switch set to 1, the RTS line will be toggled between high and low to control Half Duplex communication.

### B:5.4 Stop Bits

This switch determines whether one (Switch = 0) or two (Switch = 1) stop bits will be transmitted with each character.

## Switch Group B.6

### B:6.1 Data Bits

Number of data bits per character. This feature allows the terminal to transmit and receive either seven or eight data bits per character via the I/O port. When the Switch is set to 1, the word length is set to 8 data bits.

### B:6.2 8th Data Bit, 1/0

This feature determines whether the 8th data bit will be a logical 0, Space (Switch = 0) or a logical 1, Mark (Switch = 1).

### B:6.3 Parity Sense

If parity is enabled (see switch B:6.4) the Parity Sense Switch determines the type of parity checking and generation to be used by the terminal at the I/O port. When the switch is set to 1, even parity is used and when set to 0, odd parity is used. If at any time a received character does not have the required parity, the character is rejected and an error symbol is displayed instead of the character.

### B:6.4 Parity

When enabled (Switch = 1), the terminal will add a parity bit to each character transmitted via the I/O port, and will verify the parity of each received character, according to the type of parity (odd or even) selected by the Parity Sense switch.

## 9.5.2 TRANSMIT AND RECEIVE SPEEDS

The transmit and receive data rates may be set independently, the values selected being indicated on the Set-up B display. The range of data rates for both is the same, namely 75, 110, 134.5, 150, 200, 300, 600, 1200, 2000, 2400, 4800, 9600, 19200 bits/sec. To change the transmit speed the 7 key is used and to change the receive speed the 8 key is used. In both cases, for each depression of the key the speed increases by one step (the auto-repeat facility can be used, if enabled) until the 19200 rate is reached. The next key depression will reset to the minimum (75 bits/sec) rate, after which the increase will be repeated.



9.6 SET-UP C

The Set-up C display shows six groups of four switches at the bottom left, and the printer port transmit speed at the bottom right.

Each switch has two positions, 0 and 1. To select a switch, move the cursor until it is above the requi-

red switch, when its current function will be shown underlined. To change the switch status and function, depress the 6 key. Another depression of the 6 key will toggle the switch back again. The individual switch functions are described below and summarised in Appendix 3.

9.6.1 SET UP C SWITCHES

Note: Factory default settings are underlined.

Group 1 Switches:

	1	0
SEND KEY	Block	<u>Extent</u>
SEND EXTENT	Line	<u>Page</u>
SEND REQUEST	Direct	<u>Indirect</u>
SEND	All	<u>Unprot. only</u>

Group 2 Switches:

	1	0
SEND	All	<u>To Cursor</u>
TRANSPAR MODE	Enabled	<u>Disabled</u>
COMMAND MODE	<u>ANSI</u>	Custom
BIG/FLIP PAGE	BigPage	<u>Flip</u>

Group 3 Switches:

	1	0
STATUS LINE		
STATUS LINE	User	<u>Status</u>
CURSOR POSITION	Enabled	<u>Disabled</u>
TIME	Enabled	<u>Disabled</u>
TERMINAL MODE	<u>Enabled</u>	Disabled

Group 4 Switches:

	1	0
STATUS LINE		
PRINTER STATUS	Enabled	<u>Disabled</u>
TRANSMIT	Enabled	<u>Disabled</u>
INTERFACE	Enabled	<u>Disabled</u>
BUFFER %	Enabled	<u>Disabled</u>

Group 5 Switches:

	1	0
PRINT KEY	Block	<u>Operation</u>
PRINT EXTENT	All	<u>Scrolling Region</u>
PRINT	All	<u>To Cursor</u>
STOP BITS	2	<u>1</u>

Group 6 Switches:

	1	0
PRINTER		
DATA BITS 8/7	8	<u>7</u>
8th DATA BIT	1 (Mark)	<u>0 (Space)</u>
PARITY SENSE	Even	<u>Odd</u>
PARITY	Enabled	<u>Disabled</u>

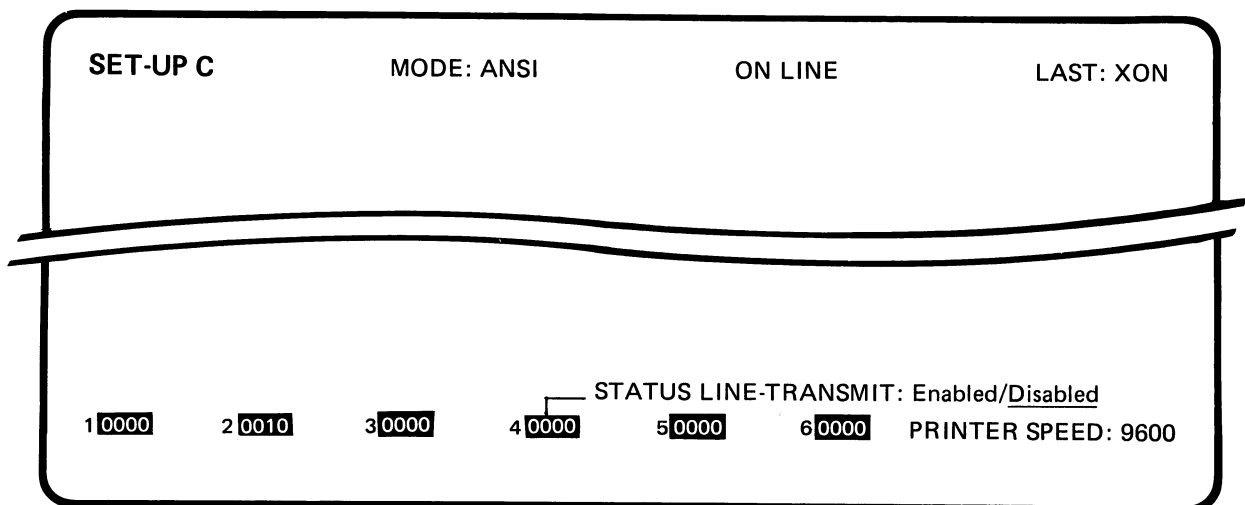

Fig.25 Set-up C Display

## Switch Group C.1

### C:1.1 Send Key

This feature determines the type of Send operation performed when the [ENTER/PRINT] key is depressed and the terminal is in Block Mode. When the switch is set to 1 the terminal will send the data between Block Markers (see Section 7.3). When the switch is set to 0 the extent of the Send operation (line or page) is determined by the setting of the Send Extent Switch C:1.2.

### C:1.2 Send Extent

When this Switch is set to 0 the terminal is configured to send the current active page (denoted by the cursor). With the Send Extent Switch set to 1 the current line denoted by the cursor is sent.

A further Switch in Custom Mode Set-up 4 (Section 10.6.2) determines whether the entire line or page is sent, or only data up to and including the current cursor position.

### C:1.3 Send Request

When this Switch is set to 1 (Direct), data is block sent upon depression of the [SEND INITIATE] key, [RETURN] (Send Line Only) or the [ENTER/PRINT] key. When the Switch is set to 0 (Indirect, Default) a code is transmitted to the host to indicate that a block of data is ready for transmission. The host responds with a Remote Send Initiating Command.

### C:1.4 Send (Data Type)

With this switch set to 0 the terminal will send only unprotected data; Send Partial. With the switch set to 1 all data (protected and unprotected) will be sent; Send All. This feature is only operational when in Format Mode (Section 7.4).

## Switch Group C.2

### C:2.1 Send: (Full Extent/To Cursor).

When this switch is set to 1, a Block Send operation will send all data on the current line or page; dependent on the setting of the Send Key and Send Extent switches in Set Up C. When this switch is set to 0 a Block Send operation will transmit data up to and including the current cursor position.

### C:2.2 Transparency Mode

When the switch is set to 0, the terminal displays only normal displayable characters. When the switch is set to 1 any control codes (Hex 00 to Hex 1F and 7F) are displayed on the screen in reverse video as a \* followed by the corresponding alpha character, e.g. Control A (Hex 01) is displayed as <\*A>. The Commands are not obeyed, so that the terminal displays a continuous string of intermixed control codes and characters.

### C:2.3 Command Mode.

When enabled (Switch = 1, Default) the terminal will act according the ANSI Command Set. When disabled (Switch = 0) the terminal will act according to the Custom Default command set or Custom Reassigned set as defined by Custom Mode programming.

### C:2.4 Big Page/Flip Page Mode

With the switch set to 1 the terminal is in the Big Page Mode, i.e. in Portrait Format a page of 72 lines is displayed, and in the Landscape Format any consecutive 24 lines of the 72 lines held in memory will be displayed. With the switch set to 0 the terminal is in Flip Page Mode, i.e. in the Portrait Format three independent pages each of 24 lines will be displayed, whilst in the Landscape Format one 24 line page will be shown. Refer to Section 5.1, Screen Handling and Multipage Operation.

**Note:** In Big- Page mode the terminal will display more than 24 lines **provided** that the host can transmit more than 24 lines.

## Switch Group C.3

Set-up C Switch Groups 3 and 4 control the configuration of the Status/Diagnostic line which will appear at the bottom of the screen display. The Status Line must be enabled according to the setting of Switches B:3.2 for this information to be displayed.

### C:3.1 Status Line - User/Status.

This Switch must be set to 1 for user messages to be displayed at the bottom of the screen (see Section 15.19 for information on loading the user line). With the switch set to 0, status and diagnostic information (as selected in Set-up Mode C) is displayed on the Status Line.

### C:3.2 Status Line - Cursor Position.

With this feature enabled (Switch = 1) the current cursor position, defined in terms of the page, row and column will be displayed on the Status Line.

### C:3.3 Status Line - Time

With this feature enabled (Switch = 1) the real time will be displayed in a 24 hour format on the Status Line. The time readout may be set by the host using the Load Time Command.

### C:3.4 Terminal Mode

With this feature enabled (Switch = 1) Terminal Mode information will be displayed on the Status Line.

## Switch Group C.4

### C:4.1 Status Line - Printer Status.

With this feature enabled (Switch = 1) the type of Print Operation currently selected is displayed on the Status Line.

### C:4.2 Status Line - Transmit

With this feature enabled (Switch = 1) the type of Send Operation currently selected is displayed on the Status Line.

### C:4.3 Status Line - Interface

With this feature enabled (Switch = 1) the status of Printer Ready/Busy, Printer XON/XOFF and I/O XON/XOFF or I/O Ready/Busy is monitored on the Status Line.

### C:4.4 Status Line - Buffer %

With this feature enabled (Switch = 1) the number of characters in the input buffer is displayed in a Bar-Graph format. There are 8 blocks on the graph which fill from left to right as the buffer is loaded (up to a maximum of 256 characters). When the first block position is filled there are between 1 and 32 characters in the buffer. For each additional 32 characters in the buffer, another block in the bar graph is filled in. When the buffer contains 160 or more characters, the bar graph appears in reverse video and blinks. If the buffer overflows an Error Marker is inserted in the data stream and is hence displayed on the screen. If this happens is it very likely that there is a protocol problem, which must be investigated.

## Switch Group C.5

### C:5.1 Print Key

The setting of this Switch determines the type of Print operation the terminal will perform in response to simultaneous depression of the [SHIFT + ENTER/PRINT] keys. With the Switch set to 1 the terminal will print the data between Block Markers (see Section 7.3). When set to 0, the extent of the Print operation (line or page) is determined by the setting of the Print Extent Switch C:5.2.

### C:5.2 Print Extent

When set to 0 this Switch configures the terminal to print the scrolling region, providing the cursor is positioned within this region. If the cursor is outside the scrolling region there will be no print-out. This case is applicable when the Custom Mode Set-up 4 Switch CM:2.4 is set for Page. See also Switch C:5.3, Print:All/To Cursor which also determines the extent of the printout.

If the Custom Mode Set-up 4 Switch CM:2.4 is set for Line, with the Print Extent Switch set to 0 the line denoted by the cursor will only be printed if it lies within the scrolling region. Again this is also dependent on Switch C:5.3.

If the Print Extent Switch is set to 1, the whole page (active page as indicated by the cursor) will be printed out subject to the settings of Switches CM:2.4 and C:5.3.

### C:5.3 Print (All/To Cursor)

When this Switch is set to 1, a Print operation will print all data on the current Line/Page; dependent on the settings of the Print Key and Print Extent switches in Set-up Mode C. With the Switch set to 0, a Print operation will transmit data up to and including the current cursor position.

### C:5.4 Stop Bits - Printer

This switch determines whether one (Switch = 0) or two (Switch = 1) stop bits will be transmitted with each character to the Printer.

## Switch Group C.6

### C:6.1 Data Bits - Printer

Number of data bits per character. This feature allows the terminal to transmit and receive either seven or eight bits per character via the Printer port. When the switch is set to 1, eight data bits are selected; when set to 0, seven data bits are selected.

### C:6.2 8th Data Bit, Printer

This feature determines whether the 8th data bit will be a logical 0, Space (Switch = 0) or a logical 1, Mark (Switch = 1).

### C:6.3 Parity Sense - Printer

If parity is enabled (see next switch, Parity) the Parity Sense switch determines the type of parity checking and generation to be employed by the terminal at the Printer Port. When the switch is set to 1, even parity is used and when set to 0, odd parity is used. If at any time a received character does not have the required parity, the character is rejected and an error symbol (checkerboard) is displayed.

### C:6.4 Parity - Printer

When enabled (Switch = 1), the terminal will include a parity bit with each character transmitted via the Printer Port, and will verify the parity of each received character, according to the type of parity (odd or even) selected by the Parity Sense switch.

## 9.6.2 PRINTER BAUD RATE

Control of the printer port data transmission rate is effected by either the 7 or 8 key in the same way as described in Section 9.5.2, Transmit and Receive Speeds, above.

# 10. CUSTOM MODE

## 10.1 INTRODUCTION

In the same way as software is used to set the operational parameters in the Set-up Modes, this series of four Custom Mode Set-up displays permits fundamental changes to be customized for any special user needs. These changes can be made via software switches shown on the Custom Mode Set-up displays or alternatively loaded via the interface by the host computer, and can be permanently stored in the terminal. In order to ensure a given initial state for all parameters when the terminal is switched on the required values are stored in a non-volatile EAROM, so that these values will be preserved even when the power is off. When the terminal is switched on, the stored initial values are used. At any time the user or the host may change any of the current customized parameters, either:

- (a) Temporarily (at most, until the terminal is next switched off), in which case the values in ROM remain unchanged and will be used when the terminal is next switched on or reset.
- (b) Permanently, by replacing the EAROM values with the temporary parameters, thereby changing the switch-on state of the terminal.

Note that most of the parameters can be changed remotely by the host, but these changes are only in the temporary category. The only way to permanently store new parameter values is to perform the Save operation from the keyboard, using [SHIFT] + S as detailed in Section 9.2.7.

The user may also at any time reset all the parameters to their power up settings.

The terminal sets up tables in EAROM to store customized Control Code and Escape Sequence assignments, as shown in Fig. 26. This illustrates the method of defining Escape Sequences via Custom Mode Set-up 3. The figure shows the assignment of three command sequences.

The first is code 1B (ESC) which is assigned to function 206, the Lead-In Code; therefore ESC is the lead-in code to the command sequences.

The second assignment is code 1C to function 202, Backspace. Because Hex 1C is lower than Hex 20, it and all other codes lower than Hex 20 are assigned without the lead-in code; therefore Hex 1C assigned on its own will result in Backspace.

The third assignment is code 41 to function 78, Insert Line. Because Hex 41 is higher than Hex 20, it and all other codes higher than Hex 20 must be assigned preceded by the lead-in code; therefore Lead-in Code + Hex 41 will result in Insert Line.

Up to a maximum of 111 commands can be customized in this way and be stored either temporary or permanently.

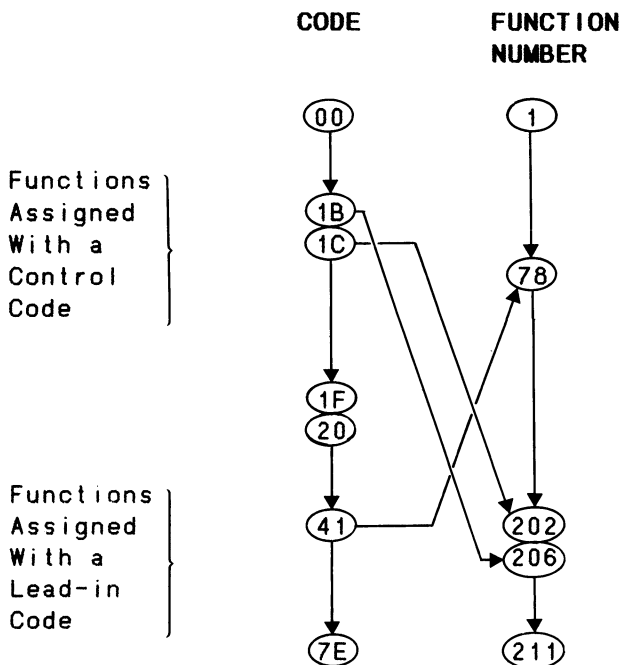

EAROM; COMMAND SEQUENCE TABLE

1B	206
1C	202
41	78

Fig. 26 Customized Codes - Assignment and Storage in EAROM

## 10.2 CUSTOM MODE SET-UP DISPLAYS

The operator uses the four Custom Mode Set-up displays to display and program the terminal's response to control codes and escape sequences. This series of displays is also used to program the keyboard.

As the operation of the terminal may be dramatically altered by using the Custom Mode, it is recommended that the System manager of the installation is consulted before implementing any changes by means of this Mode. It is also recommended that if extensive modifications are done, the Save Inhibit function is made operational, so that the alterations can be checked before being stored permanently in the EAROM. The Custom programmed parameters can then always be restored to their original values by implementing RESET.

The Save Inhibit function is implemented by jumpers W4 and W7 on the Main Logic Board; refer to Section 29.1 for details.

## 10.3 CUSTOM MODE SET-UP 1

### 10.3.1 DISPLAYING CONTROL CODE DEFINITIONS

To review the list of current Control Code Definitions use the [CURSOR UP] and [CURSOR DOWN] keys to scroll through the list one control code at a time. To cancel the definition of a control code, scroll through the list until the desired code is displayed, and then depress [CONTROL] + [DELETE] (the [BS/DEL] key on the alphanumeric key pad). Subsequently, unless the control code is redefined as described below, the terminal will perform the

### 10.2.1 ENTERING THE CUSTOM MODE

To enter the Custom Mode, first enter the Set-up A Mode and then depress [CONTROL] + [SET-UP]. The Current Control Code Definitions display (Custom Mode Set-up 1) will be shown (Fig. 27).

The number of bytes of non-volatile memory (EAROM) available for Custom Mode definitions (and user programmable Function key messages) is displayed at the top right of each Custom Mode Set-up display. Any attempt to define control codes or escape sequences when sufficient memory is not available will be ignored. Up to five code sequences may be assigned to each function (as long there is sufficient EAROM memory available). Each code sequence, however, may be assigned to only one function. An attempt to assign the same code sequence to two functions is rejected and the error message "Code Previously Defined" is displayed.

### 10.2.2 EXITING THE CUSTOM MODE

Press [SET-UP] once to return to the Set-up A Display, and once more to return to the normal screen.

default function (if any) for this code as specified in the function definition.

The number of currently defined control codes is displayed to the left of the words: "CUSTOMIZED CONTROL CODES". The function number is at the left of the FUNCTION position in the AVAILABLE FUNCTIONS table.

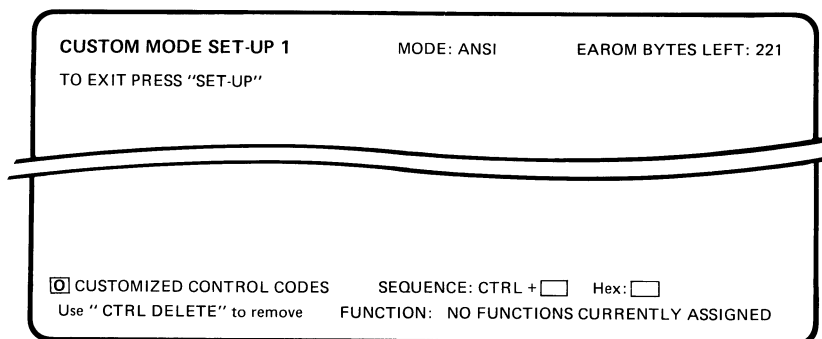

Fig. 27 Custom Mode Set-up 1 Display

## 10.4 CUSTOM MODE SET-UP 2

### 10.4.1 DISPLAYING ESCAPE SEQUENCE DEFINITIONS

To review the list of current Escape Sequence Definitions depress the 5 key to show the Custom Mode Set-up 2 display (Fig. 28) and use the CURSOR UP and DOWN keys to scroll through the list. To cancel the definition of an Escape Sequence scroll through the list until the desired Sequence is displayed, and then depress [CONTROL] + [DELETE] (the [BS/DEL] key on the alphanumeric key pad). Subsequently, unless

the Escape Sequence is redefined as described below, the terminal will perform the default function (if any) for this code as specified in the function definition.

The number of currently defined Escape Sequences is displayed to the left of the words: "CUSTOMIZED ESCAPE SEQUENCES".

```

CUSTOM MODE SET-UP 2          MODE: ANSI          EAROM BYTES LEFT: 221
TO EXIT PRESS "SET-UP"

[ ] CUSTOMIZED ESCAPE CODES    SEQUENCE: ESCAPE [ ]  Hex: [ ]
Use "CTRL DELETE" to remove   FUNCTION: NO FUNCTIONS CURRENTLY ASSIGNED
  
```

Fig. 28 Custom Mode Set-up 2 Display

## 10.5 CUSTOM MODE SET-UP 3

### 10.5.1 DEFINING CONTROL CODES AND ESCAPE SEQUENCES

To assign a Control Code or an Escape Sequence to a particular type of function, depress the 5 key to enter Custom Mode Set-up 3 (Fig. 26) and use the [CURSOR UP] and [CURSOR DOWN] keys to scroll through the list until the desired function is located (Sections 11 to 23 inclusive give full details of all the functions; Appendix 4 is a summary of the functions and their codes). Then type the Control Code or Escape Sequence desired to invoke the function, followed by [CONTROL] + [RETURN], which causes the new function to be added to the list of current definitions. Successful assignment will result in the display of the newly

assigned Hex Code sequence and sound the bell. If this does not occur then either there is insufficient EAROM memory available (check the top right portion of the screen for the number of bytes available) or the code is already defined. The number of functions is displayed to the left of the words: "AVAILABLE FUNCTIONS".

A maximum of five different Control Codes or Escape Sequences can be assigned to any one function. Each code assignment must be unique, i.e. the same code cannot call different functions.

```

CUSTOM MODE SET-UP 3          MODE: ANSI          EAROM BYTES LEFT: 221
TO EXIT PRESS "SET-UP"

207 AVAILABLE FUNCTIONS      ASSIGNMENT: 1B 41
Use "CTRL RETURN" to assign FUNCTION: # 1 Cursor Up
  
```

Fig.29 Custom Mode Set-up 3 Display



**IMPORTANT NOTE**

When a new command set has been defined, and the terminal has been set to Custom Mode - the terminal will perform **only** the functions which have been assigned. Note in particular that:

1. If there is any function in the customized command set which includes "CSI", then all functions starting with CSI are available.
2. Unless the keys in the Editing Block have been redefined, their echo (from the host, or when in Local or Block Modes) will perform their functions **only** if the respective functions are defined in the new command set.

**General Notes:**

Appendix 4 lists the Control Codes and the key combinations to generate the codes.

To define the Escape (Hex 1B) Control Code depress the [ESCAPE] key.

For Custom Mode Definitions an Escape Sequence is defined as a two byte code sequence of which the first code is always Escape (Hex 1B) and the second represents a displayable character (i.e an alphabetic, numeric or symbol key). Control Codes are not allowed as the second byte of an Escape sequence in Custom Mode Set-up.

To verify the new definitions depress the 5 key several times to call up the Custom Mode Set-up 1 and Custom Mode Set-up 2 displays, respectively.

To return to the Set-up A Mode from any Custom Mode depress the [SET-UP] key.

To save permanently the new Custom Mode definitions perform a Save operation as described in Section 9.27.

**10.6 CUSTOM MODE SET-UP 4**

Custom Mode Set-up 4 contains some very system dependent functions and re-assignment of function keys and editing keys. These functions should therefore only be altered after consulting staff responsible for your host system. Refer to Sections 8.5 and 9.5 for details of the programmable function keys.

**10.6.1 PROGRAMMABLE EDIT KEYS**

The code sequences transmitted by the 12 editing keys may be re-defined in Custom Mode Set-up 4 to be either one Control Code, or a 2 byte Escape sequence of which the first code is always Escape (Hex 1B) and the second code a displayable character.

A maximum of 17 redefined codes can be obtained from these 12 keys as follows.

All 12 unshifted keys; the shifted [CURSOR UP], [CURSOR DOWN], [HOME] and [ERASE] keys; and both toggle functions of the [INSERT CHARACTER] key.

To display the current assignment depress [CTRL] + the desired Editing Key simultaneously. To re-define the key, type any character to serve as a delimiter, followed by the new control code or two-character Escape Sequence. The second character of an Escape Sequence must be a displayable character (a control code will not be accepted). To abort at this point without changing the old key definition, depress either the [SET-UP] key, or the [CONTROL] key and any Editing key. To assign the new code sequence type the delimiter character again. The bell will sound to acknowledge acceptance of the new code sequence and the Definition display will be cleared.

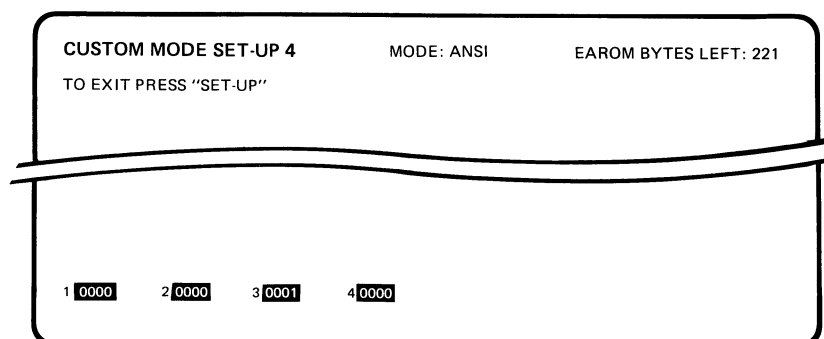

**Fig. 30 Custom Mode Set-up 4 Display**

## 10.6.2 CUSTOM MODE SET-UP 4 SWITCHES

**Note:** Factory default settings are underlined.

### Group 1 Switches:

	1	0
WRAP-AROUND	Enabled	<u>Disabled</u>
NEW LINE	Enabled	<u>Disabled</u>
DISPLAY REPORT	<u>Request</u>	Auto
PAGE MODE	Enabled	<u>Disabled</u>

### Group 2 Switches

	1	0
PRINT TERM.	Formfeed	<u>None</u>
PRINT EXPAND	Enabled	<u>Disabled</u>
SCREEN SAVER	Enabled	<u>Disabled</u>
PRINT KEY OP.	Page	<u>Line</u>

### Group 3 Switches

	1	0
PRINT PAGE	All	<u>Active</u>
EDIT KEYS	<u>Duplex</u>	Local
ATTRIBUTES		
OFF PROTECTED	Enabled	<u>Disabled</u>
BLANK PROT.	Enabled	<u>Disabled</u>

### Group 4 Switches

	1	0
BOLD PROTECTED	Enabled	<u>Disabled</u>
BLINK PROT	Enabled	<u>Disabled</u>
REVERSE PROT	Enabled	<u>Disabled</u>
UNDERLINE PROT	Enabled	<u>Disabled</u>

## Switch Group CM.1

### CM:1.1 Wrap Around

When this feature is enabled (Switch = 1), after entry of a character in the last position on a line (80th unless redefined by the Set Vertical Margin Function), the cursor will automatically move to the first position on the line below. When disabled (Switch = 0), any attempt to enter more than 80 characters on a line will result in overwriting the last character on the displayed line.

### CM:1.2 New Line

When the New Line feature is enabled (Switch = 1), depression of the [RETURN] key will cause both the Carriage Return (CR) and Line Feed (LF) codes to be transmitted, when the terminal is in the On-Line Mode. When the LF code is received by the terminal, both a Carriage Return and a Line Feed are performed on the screen. When the feature is disabled (Switch = 0), the [RETURN] key will transmit only a CR code, and receipt of the LF code will result in a Line Feed only on the screen.

### CM:1.3 Display Report

When this feature is set to auto (Switch set to 0), a report will be sent to the host automatically each time the display is twisted. If the switch is set to 1 (Request), the screen mode report only will be sent when requested by the host.

### CM:1.4 Page Mode

When the Page Mode is enabled LF commands in the bottom row and reverse LF commands in the top and bottom rows cause the cursor to wrap around to the top and bottom rows of the screen respectively. When Page Mode is disabled LF commands in the bottom row and reverse LF in the top row initiate scroll up or scroll down operations respectively.

## Switch Group CM.2

### CM:2.1 Print Terminator

When this Switch is set to 1, the terminal will add a Form Feed code (Hex 0C) to the end of the data sent to the printer after each printed page initiated by the Print Page or Print Screen commands. The default state is set by a switch in the Set-up mode.

When the Switch is set to 0, no code will be added to the page data.

**CM:2.2 Print Expanded Mode**

With the "EXPANDED PRINT MODE" enabled it is possible to send out all data on the screen to the printer port formatted with interleaved codes at all transitions between character set shifts and attribute shifts. Normal characters are sent out as their normal ASCII codes and semigraphic characters (stored as control codes) are sent out as they are stored in the screen RAM - but with bits 6 and 7 set to 1 (i.e. columns 0 and 1 transferred to columns 6 and 7) - and preceded and succeeded by appropriate escape sequences.

**CM:2.3 Screen Saver**

With this Switch enabled, the screen will automatically blank after 10 minutes of inactivity, but will be restored upon receipt of any data from the host or when any key is depressed. A key depression which restores the display does not cause any code to be transmitted or character to be displayed.

**CM:2.4 Print Key Operation**

This Switch is set to 1 for Page, and 0 for Line.

**Switch Group CM.3****CM:3.1 Print Page**

This Switch is set to 1 for All pages, and 0 for Active Page.

**CM:3.2 Edit Keys - Duplex/Local**

This switch determines whether the Edit Keys will perform their function locally (Switch = 0,) or will transmit the appropriate code sequence to the host (Switch = 1).

**CM:3.3 Attributes Off Protected**

When this switch is set to 1 and Format Mode is in operation, all data stored in the screen memory which have no video attributes are protected.

**CM:3.4 Blank Not Protected**

When this Switch is set to 0 and Format Mode is in operation (see Section 7.4), all data stored in the screen memory with the Blank (Non-Displayed) attribute are protected.

**Switch Group CM.4****CM:4.1 Bold Protected**

When this Switch is set to 1 and Format Mode is in operation, all data stored in the screen memory with the Full Intensity attribute are protected. Half Intensity data are unprotected.

**CM:4.2 Blink Protected**

When this Switch is set to 1 and Format Mode is in operation, all data stored in the screen memory with the Blinking attribute are protected.

**CM:4.3 Reverse Protected**

When this Switch is set to 1 and Format Mode is in operation, all data stored in the screen memory with the Reverse Video attribute are protected.

**CM:4.4 Underline Protected**

When this Switch is set to 1 and Format Mode is in operation, all data stored in the screen memory with the Underline attribute are protected.

**10.7 DOWNLINE CUSTOMIZATION**

Customization can be done by downloading from the host computer. As the operation of the terminal may be dramatically altered when downloading, it is recommended that the System manager of the installation is consulted before implementing any changes by means of this function.

There are three functions associated with downline loading (For details refer to Section 25).

- Downline loading of user definable function keys
- Downline loading of command codes
- Report available EAROM.

## 11. INTRODUCTION TO TERMINAL CONTROL FUNCTIONS

The functions of the terminal can be controlled by commands transmitted from the host computer using ANSI, Custom or Reassigned Custom codes as described in the following sections.

### 11.1 ANSI MODE

ANSI codes are standardized escape sequences as recommended in the American National Standards Institute documents ANSI X3.41-1974 and ANSI X3.64-1977.

All ANSI commands begin with the hexadecimal code 1B, representing "Escape". This will terminate any previously started but so far incomplete command sequence. In many cases the next byte is 5B, representing [. The character pair 1B 5B is called the "Control Sequence Introducer", or CSI, and following the CSI are parameters, such as Pn or Ps.

Pn represents a numerical value, for example the CURSOR UP command may be 1B 5B 31 30 41, where 31 30 = 10 (decimal) and is the number of lines that the cursor must move upwards. The code sequence in this case is terminated by 41, representing A. Where the ANSI code sequence includes Ps, this represents a selection from certain numerical commands. Only these commands will be accepted, and they provide preselected parameters. For example, the Clear Tab Stop command Ps value may only be 0 or 3, all other numerical values for Ps will be ignored.

### 11.2 CUSTOM DEFAULT FUNCTIONS

For Custom Default functions with parameters, the lowest parameter values in the ANSI range of possibilities are used. Thus the Custom Default code for Cursor Up (1B 41) moves the cursor up one line only. Otherwise the Custom Default commands mainly employ the 2-byte sequences that are generally used in a non-ANSI environment.

### 11.3 REASSIGNED FUNCTION CODES

Reassigned Custom functions permit a mixture of Custom Default functions and Customized- or Reassigned- functions. A Reassigned Custom code may begin with a CSI, in which case the command will result in an ANSI function. If any other introductory code is used, the result will be a Customized function.

Section 10, Custom Mode, describes the assignment and implementation of custom codes via the software switches, in the Set-up Mode or downline loaded from the host.

Reassigned Custom function codes may be written into the blank spaces which have been left in the following pages for this purpose, so that the user can keep a permanent record of such codes.

The recognised basic Control Codes are given on the following page.

### 11.4 CUSTOMIZATION OF CONTROL CODES

The terminal has 66 functions assigned in the Custom Default Mode. Particular attention must be given to two of these functions.

- No. 206 Lead-in Code
- No. 207 Control Sequence Introducer

Function No. 206 defines the code that will be used as the Lead-in Code for the command sequences, normally this function is assigned as ESC (Hex 1B), although this is not obligatory. If this function is unassigned, the Lead-in Code will not be assigned therefore the command codes cannot be enabled.

If the Lead-in Code is assigned to a code other than ESC, care must be taken to ensure that a command set is built-up which is consistent (i.e. the same Lead-in Codes), otherwise erroneous results may occur.

Only control characters can be assigned as a lead-in code.

Function No. 207 defines the code which will be used as the Control Sequence Introducer (CSI), normally this function is assigned as ESC [ (Hex 1B 5B). If CSI is assigned, then the Custom Default Mode will be "enhanced" with the ANSI functions which begin with CSI. If the function is unassigned, only the custom default functions will operate in the Custom Default Mode. If CSI is assigned to a code other than ESC [, then all implications have to be carefully considered.

## 11.5 CONTROL CODES

<u>Function Number</u>	<u>Function</u>	<u>ANSI and Custom Default</u>		<u>Reassigned</u>
		Hex Code	ASCII Character	
200	Send Answerback Message	05	ENQ	_____
201	Sound Bell	07	BEL	_____
202	Backspace	08	BS	_____
203	Line Feed	0A/0B/0C	LF/VT/FF	_____
204	Carriage Return	0D	CR	_____
205	Cancel Escape Sequence (Only Hex 1A is a custom default)	18 & 1A	CAN & SUB	_____
206	Lead-in Code	1B	ESC	_____
207	Control Sequence Introducer	1B 5B	ESC [	_____
-	Stop Host Transmission	13	DC3	N/a
-	Start Host Transmission	11	DC1	N/a
-	Stop Terminal Transmission	13	DC3	N/a
-	Start Terminal Transmission	11	DC1	N/a

## 12. CURSOR MOVEMENT COMMANDS

### INTRODUCTION

These commands control the movement and location of the cursor on the screen, and include commands to switch the cursor on or off, save or restore its position. The cursor defines the active position, where data is entered or modified according to the user's requirements.

### LIST OF COMMANDS

- 12.1 CURSOR UP
- 12.2 CURSOR DOWN
- 12.3 CURSOR FORWARD
- 12.4 CURSOR BACKWARD
- 12.5 CURSOR POSITION, ANSI
- 12.6 CURSOR POSITION, VT52
- 12.7 CURSOR POSITION, ADM 3A
- 12.8 CURSOR POSITION, ADDS
- 12.9 CURSOR POSITION, H1500
- 12.10 CURSOR POSITION, TDV 2215/20
- 12.11 HORIZONTAL AND VERTICAL POSITION
- 12.12 CURSOR HOME
- 12.13 SAVE CURSOR
- 12.14 RESTORE CURSOR
- 12.15 CURSOR OFF
- 12.16 CURSOR ON
- 12.17 CURSOR BLINK
- 12.18 CURSOR STEADY
- 12.19 CURSOR UNDERLINE
- 12.20 CURSOR BLOCK
- 12.21 INDEX
- 12.22 NEXT LINE
- 12.23 REVERSE INDEX

**12.1 CURSOR UP**

This sequence moves the cursor up without altering its column position. The distance moved is determined by Pn, thus if the value of Pn is N, the cursor is moved N lines up; if zero or 1, the cursor is moved one line up. When attempting to move the cursor above the top margin, the cursor stops at the top margin.

**12.2 CURSOR DOWN**

This sequence moves the cursor down without altering its column position. The distance moved is determined by Pn, thus if the value of Pn is N, the cursor is moved N lines down; if zero or 1, the cursor is moved one line down. When attempting to move the cursor below the bottom margin, the cursor stops at the bottom margin.

**12.3 CURSOR FORWARD**

This sequence moves the cursor to the right as determined by Pn, thus if the value of Pn is N the cursor is moved N places to the right; if zero or 1, the cursor is moved one column to the right. When attempting to move the cursor to the right of the right margin, the cursor stops at the right margin.

**12.4 CURSOR BACKWARD**

This sequence moves the cursor to the left as determined by Pn, thus if the value of Pn is N the cursor is moved N places to the left; if zero or 1, the cursor is moved one column to the left. When attempting to move the cursor beyond the left margin, the cursor stops at the left margin.

**Function No. 1**

ANSI: 1B 5B Pn 41  
CSI Pn A

CUSTOM  
DEFAULT: 1B 41  
ESC A

REASSIGNED: \_\_\_\_\_

**Function No. 2**

ANSI: 1B 5B Pn 42  
CSI Pn B

CUSTOM  
DEFAULT: 1B 42  
ESC B

REASSIGNED: \_\_\_\_\_

**Function No. 3**

ANSI: 1B 5B Pn 43  
CSI Pn C

CUSTOM  
DEFAULT: 1B 43  
ESC C

REASSIGNED: \_\_\_\_\_

**Function No. 4**

ANSI: 1B 5B Pn 44  
CSI Pn D

CUSTOM  
DEFAULT: 1B 44  
ESC D

REASSIGNED: \_\_\_\_\_

### 12.5 CURSOR POSITION, ANSI

This sequence moves the cursor to the position determined by the two parameters Pnl and Pnc. Pnl specifies the line position and Pnc specifies the column position. A value of zero or 1 in Pnl places the cursor in the first line; a value of zero or 1 in Pnc places the cursor in the first column. Thus values of 15 and 10 in the parameters Pnl and Pnc will move the cursor to line 15, column 10. The default condition, with no parameters present (Hex 1B 5B 48) is equivalent to a Home command, and the cursor will move to the top left corner of the screen. The line numbering depends on the state of the Origin Mode.

### Function No. N/a

ANSI:           1B 5B Pnl 3B Pnc 48  
                  CSI Pnl ; Pnc H

CUSTOM  
DEFAULT:       Not Applicable

REASSIGNED: Not Applicable

### 12.6 CURSOR POSITION, VT52

To position the cursor using this command mode the introductory lead-in code is followed first by a line code (line number plus Hex 20, i.e. Hex 20 to 37) and then by a column code (column number plus Hex 20, i.e. Hex 20 to 6F). The Home position is line Hex 20, column Hex 20. Line and column codes outside the stated ranges are ignored.

### Function No. 6

ANSI:           Not Applicable

CUSTOM  
DEFAULT:       1B 59 PI Pc  
                  ESC Y PI Pc

REASSIGNED: \_\_\_\_\_

### 12.7 CURSOR POSITION, ADM 3A

To position the cursor using this command mode the introductory lead-in code is followed first by a row number and then by a column number. The Home position is row Hex 20, column Hex 20. In Flip-page mode row numbers up to 24 are allowed, while in Big-page mode row numbers up to 72 are allowed. Row and column numbers outside the stated ranges are ignored.

### Function No. 7

ANSI:           Not Applicable

CUSTOM  
DEFAULT:       <Command> Pr Pc

REASSIGNED: \_\_\_\_\_

### 12.8 CURSOR POSITION, ADDS

To position the cursor using this command mode the introductory lead-in code is followed first by a row number and then by a column number. The Home position is row Hex 20, column Hex 20. In Flip-page mode row numbers up to 24 are allowed, while in Big-page mode row numbers up to 72 are allowed. If either the row or column numbers are outside the stated ranges the illegal number is ignored (or both if both are illegal).

### Function No. 8

ANSI:           Not Applicable

CUSTOM  
DEFAULT:       <Command> Pr Pc

REASSIGNED: \_\_\_\_\_



**12.9 CURSOR POSITION, H1500**

To position the cursor using this command mode the introductory lead-in code is followed first by a column number and then by a row number. The Home position is column Hex 00, row Hex 00; Column numbers start from Hex 00 to Hex 4F and Hex 60 to Hex 7E. Row numbers start from Hex 00 to Hex 17, Hex 20 to Hex 37, Hex 40 to Hex 57 and Hex 60 to Hex 77. Normally in Flip-page mode row numbers up to 24 are allowed, but the implications of the different addressing possibilities has to be considered. While in Big-page mode row codes up to 72 are allowed. If either the row or column numbers are outside the stated ranges, the illegal number is ignored (or both if both are illegal).

**12.10 CURSOR POSITION TDV 2215/20**

To position the cursor using this command mode the introductory lead-in code is followed first by a row number and then by a column number. The Home position is row Hex 00, column Hex 00. In Flip-page mode row numbers up to 24 are allowed, while in Big-page mode row numbers up to 72 are allowed. If either the row or column numbers are outside the stated ranges, the illegal number is ignored (or both if both are illegal).

**12.11 HORIZONTAL AND VERTICAL POSITION**

This sequence has the same function as "CURSOR POSITION", see above.

**12.12 CURSOR HOME**

This function moves the cursor to the Home position, the first unprotected position on the actual page. Also dependent for line numbering on the Origin Mode - see "CURSOR POSITION" above.

**12.13 SAVE CURSOR**

This sequence causes the cursor position, video attributes and character set to be saved. These values are restored by using the RESTORE CURSOR command (see below).

**Function No.** 9**ANSI:** Not Applicable**CUSTOM**  
**DEFAULT:** <Command> Pc Pr**REASSIGNED:** \_\_\_\_\_**Note:** Hex 7E cannot be used as a lead-in code.**Function No.** 10**ANSI:** Not Applicable**CUSTOM**  
**DEFAULT:** 10 Pr Pc  
DLE Pr Pc**REASSIGNED:** \_\_\_\_\_**Function No.** N/a**ANSI:** 1B 5B Pnl 3B Pnc 66  
CSI Pnl ; Pnc f**REASSIGNED:** Not Applicable**Function No.** 12**ANSI:** 1B 5B 48  
CSI H**CUSTOM**  
**DEFAULT:** 1B 48  
ESC H**REASSIGNED:** \_\_\_\_\_**Function No.** 13**ANSI:** 1B 37  
ESC 7**CUSTOM**  
**DEFAULT:** 1B 37  
ESC 7**REASSIGNED:** \_\_\_\_\_

**12.14 RESTORE CURSOR**

This sequence causes the previously saved cursor position, video attributes and character set to be restored to the screen (see the SAVE CURSOR command above).

**12.15 CURSOR OFF**

On receipt of this command, the cursor is not displayed, otherwise there is no functional difference. The cursor can be turned on by the CURSOR ON command.

**12.16 CURSOR ON**

This function turns the cursor on if it was turned off by the CURSOR OFF function (see above).

**12.17 CURSOR BLINK**

The cursor symbol will blink when this function code is received.

**12.18 CURSOR STEADY**

The cursor symbol will remain steady when this function code is received.

**Function No. 14**

ANSI: 1B 38  
ESC 8

CUSTOM  
DEFAULT: 1B 38  
ESC 8

REASSIGNED: \_\_\_\_\_

**Function No. 15**

ANSI: 1B 5B 3F 33 35 68  
CSI ? 3 5 h

CUSTOM  
DEFAULT: 1B 5B 3F 33 35 68  
CSI ? 3 5 h

REASSIGNED: \_\_\_\_\_

**Function No. 16**

ANSI: 1B 5B 3F 33 35 6C  
CSI ? 3 5 I

CUSTOM  
DEFAULT: 1B 5B 3F 33 35 6C  
CSI ? 3 5 I

REASSIGNED: \_\_\_\_\_

**Function No. 17**

ANSI: 1B 5B 3F 33 34 68  
CSI ? 3 4 h

CUSTOM  
DEFAULT: 1B 5B 3F 33 34 68  
CSI ? 3 4 h

REASSIGNED: \_\_\_\_\_

**Function No. 18**

ANSI: 1B 5B 3F 33 34 6C  
CSI ? 3 4 I

CUSTOM  
DEFAULT: 1B 5B 3F 33 34 6C  
CSI ? 3 4 I

REASSIGNED: \_\_\_\_\_

**12.19 CURSOR UNDERLINE**

This function provides a cursor symbol in the form of a short underline.

**Function No.** 19

**ANSI:** 1B 5B 3F 33 33 68  
CSI ? 3 3 h

**CUSTOM**

**DEFAULT:** 1B 5B 3F 33 33 68  
CSI ? 3 3 h

**REASSIGNED:** \_\_\_\_\_

**12.20 CURSOR BLOCK**

This function provides a cursor symbol in the form of a solid rectangle (block).

**Function No.** 20

**ANSI:** 1B 5B 3F 33 33 6C  
CSI ? 3 3 l

**CUSTOM**

**DEFAULT:** 1B 5B 3F 33 33 6C  
CSI ? 3 3 l

**REASSIGNED:** \_\_\_\_\_

**12.21 INDEX**

This sequence causes the cursor to move down one line without changing its column position. If the cursor is at the bottom margin, a scroll up is performed.

**Function No.** N/a

**ANSI:** 1B 44  
ESC D

**CUSTOM**

**DEFAULT:** Not Applicable

**REASSIGNED:** Not Applicable

**12.22 NEXT LINE**

This sequence causes the cursor to move to the first (left-most) position on the next line down. If the cursor is at the bottom margin, a scroll up is performed.

**Function No.** 22

**ANSI:** 1B 45  
ESC E

**CUSTOM**

**DEFAULT:** 1B 5C  
ESC \

**REASSIGNED:** \_\_\_\_\_

**12.23 REVERSE INDEX**

This control sequence causes the cursor to move to the same horizontal position on the preceding line. If the cursor position is at the top margin, a scroll down is performed.

**Function No.** 23

**ANSI:** 1B 4D  
ESC M

**CUSTOM**

**DEFAULT:** 1B 49  
ESC I

**REASSIGNED:** \_\_\_\_\_

## 13. TABULATION

### INTRODUCTION

This set of seven commands concerns horizontal tabulation and the margin bell.

### LIST OF COMMANDS

- 13.1 SET TAB STOP
- 13.2 CLEAR ALL TAB STOPS
- 13.3 TABULATION FORWARD
- 13.4 TABULATION BACKWARD
- 13.5 SET MARGIN BELL AT CURSOR POSITION
- 13.6 ENABLE MARGIN BELL
- 13.7 DISABLE MARGIN BELL

#### 13.1 SET TAB STOP

This sequence sets one horizontal tab stop at the cursor position.

**Note:** The tab stops can also be set and cleared by the operator in Set-up A Mode.

#### Function No. 27

ANSI: 1B 48  
ESC H

CUSTOM  
DEFAULT: 1B 74  
ESC t

REASSIGNED: \_\_\_\_\_

#### 13.2 CLEAR ALL TAB STOPS

This control sequence causes tab stops to be cleared as specified by the parameter Ps. Default is 0.

#### Function No. 28

ANSI: 1B 5B Ps 67  
CSI Ps g

CUSTOM  
DEFAULT: None (= Ps 3)

REASSIGNED: \_\_\_\_\_

#### PARAMETER (Ps)      PARAMETER MEANING

0	Clear the horizontal tab stop at the current position of the active cursor.
3	Clear all horizontal tab stops.

Any other parameter values will be ignored.

#### 13.3 TABULATION FORWARD

The cursor is moved right to the first tab stop to the right of the cursor, on the same line. If the terminal is in Format Mode, the cursor is moved right to the first position of the next unprotected field, on the same line or the next line, as appropriate.

#### Function No. 29

ANSI: 09  
HT

CUSTOM  
DEFAULT: 09  
HT

REASSIGNED: \_\_\_\_\_

**13.4 TABULATION BACKWARD**

The cursor is moved left to the first tab stop to the left of the cursor, on the same line. If the terminal is in Format Mode, the cursor is moved left to the first position in the same field or to the first position in the previous unprotected field (which may be the last field on the previous line). If the cursor is in the Home position it will not move.

**13.5 SET MARGIN BELL AT CURSOR POSITION**

This sequence sets the margin bell position at the current horizontal cursor position.

**13.6 ENABLE MARGIN BELL**

The margin bell will sound at the end of each line (at the Margin Bell position) when this function is enabled.

**13.7 DISABLE MARGIN BELL**

The margin bell will not sound at the end of each line when this function is enabled by the code sequence.

**Function No. 30**

ANSI: 1B 42  
ESC B

CUSTOM  
DEFAULT: 1B 63  
ESC c

REASSIGNED: \_\_\_\_\_

**Function No. 31**

ANSI: 1B 5B 3F 42  
CSI ? B

CUSTOM  
DEFAULT: 1B 5B 3F 42  
CSI ? B

REASSIGNED: \_\_\_\_\_

**Function No. 32**

ANSI: 1B 5B 3F 33 37 6C  
CSI ? 3 7 I

CUSTOM  
DEFAULT: 1B 5B 3F 33 37 6C  
CSI ? 3 7 I

REASSIGNED: \_\_\_\_\_

**Function No. 33**

ANSI: 1B 5B 3F 33 37 68  
CSI ? 3 7 h

CUSTOM  
DEFAULT: 1B 5B 3F 33 37 68  
CSI ? 3 7 h

REASSIGNED: \_\_\_\_\_

## 14. SCREEN CONTROL COMMANDS

### INTRODUCTION

This set of commands controls the screen background, whether the screen is to be turned on or off, sets the page and scroll modes and the top, bottom, left and right margins.

### LIST OF COMMANDS

- 14.1 SCREEN BACKGROUND - LIGHT
- 14.2 SCREEN BACKGROUND - DARK
- 14.3 SCREEN ON
- 14.4 SCREEN OFF
- 14.5 SET PAGE MODE
- 14.6 SET SCROLL MODE
- 14.7 SET SCROLLING REGION
- 14.8 SET LEFT AND RIGHT MARGINS
- 14.9 SET SMOOTH SCROLL
- 14.10 SET JUMP SCROLL
- 14.11 ENABLE ORIGIN MODE
- 14.12 DISABLE ORIGIN MODE
- 14.13 WRAP ENABLE
- 14.14 WRAP DISABLE
- 14.15 NEW LINE ENABLE
- 14.16 NEW LINE DISABLE

**14.1 SCREEN BACKGROUND - LIGHT**

This code sequence results in a light screen with dark characters, in both the text area and the "frame". The reverse video attributes can be used so that the text area is dark with light characters, surrounded by a light frame.

**Function No. 35**

ANSI: 1B 5B 3F 35 68  
CSI ? 5 h

CUSTOM  
DEFAULT: 1B 5B 3F 35 68  
CSI ? 5 h

REASSIGNED: \_\_\_\_\_

**14.2 SCREEN BACKGROUND - DARK**

This sequence gives a dark screen background with light characters.

**Function No. 36**

ANSI: 1B 5B 3F 35 6C  
CSI ? 5 l

CUSTOM  
DEFAULT: 1B 5B 3F 35 6C  
CSI ? 5 l

REASSIGNED: \_\_\_\_\_

**14.3 SCREEN ON**

Turns the screen on after the Screen Off function has been used.

**Function No. 37**

ANSI: 1B 5B 3F 33 36 6C  
CSI ? 3 6 l

CUSTOM  
DEFAULT: 1B 5B 3F 33 36 6C  
CSI ? 3 6 l

REASSIGNED: \_\_\_\_\_

**14.4 SCREEN OFF**

The screen is blanked on receipt of this command, and can be turned on again either by the Screen On command or after entering and exiting Set-up.

**Function No. 38**

ANSI: 1B 5B 3F 33 36 68  
CSI ? 3 6 h

CUSTOM  
DEFAULT: 1B 5B 3F 33 36 68  
CSI ? 3 6 h

REASSIGNED: \_\_\_\_\_

**14.5 SET PAGE MODE**

The command sets the terminal to Scroll Disable Mode or "Page-mode". This means that when the cursor gets to the 24th or 72nd line (depending on Big Page or Flip Page Mode) no scroll is performed and the cursor is moved to the first unprotected position on the same page.

**Function No. 39**

ANSI: 1B 5B 3F 33 32 68  
CSI ? 3 2 h

CUSTOM  
DEFAULT: 1B 34  
ESC 4

REASSIGNED: \_\_\_\_\_

**14.6 SET SCROLL MODE**

This command sets the terminal to Scroll Enable, which is the default condition. This means that when the cursor gets to the 24th or 72nd line (depending on Big Page or Flip Page Mode) scrolling is performed, the cursor is moved to the first position on a new line, and the first line is lost.

**14.7 SET SCROLLING REGION**

This sequence sets the top and bottom margins which define the scrolling region. The parameter Pnb refers to the bottom line in the scrolling region. ANSI Default (i.e. Hex 1B 5B 72) is the entire screen, i.e. no margins, so that the entire screen will scroll. The minimum permitted size of the scrolling region is two lines, in which case Pnt (line number) will be the top margin, and Pnb (line number plus 1) will be the bottom margin. The cursor is placed in the Home position.

**14.8 SET LEFT AND RIGHT MARGINS**

This sequence sets the left and right margins. It is not possible to move the cursor outside these margins by means of the Cursor Movement keys, including [TAB], [LINE FEED] and [RETURN]. The minimum size of the vertical region is 2 columns. The default is columns 1 and 80, i.e. the complete screen (equivalent to Pnl = 1, Pnr = 80). Note that this function is not affected by and does not affect the margin bell.

**14.9 SET SMOOTH SCROLL**

This sequence provides "smooth" scrolling at a maximum execution rate of 6 or 12 lines per second, selectable in Set-up Mode. Smooth scrolling is not available in the Portrait Format.

**14.10 SET JUMP SCROLL**

This sequence provides "jump" scrolling from line to line instantaneously.

**Function No. 40**

ANSI: 1B 5B 3F 33 32 6C  
CSI ? 3 2 I

CUSTOM  
DEFAULT: 1B 35  
ESC 5

REASSIGNED: \_\_\_\_\_

**Function No. N/a**

ANSI: 1B 5B Pnt 3B Pnb 72  
CSI Pnt ; Pnb r

CUSTOM  
DEFAULT: 1B 5B Pnt 3B Pnb 72  
CSI Pnt ; Pnb r

REASSIGNED: Not Applicable

**Function No. N/a**

ANSI: 1B 5B Pnl 3B Pnr 76  
CSI Pnl ; Pnr v

CUSTOM  
DEFAULT: 1B 5B Pnl 3B Pnr 76  
CSI Pnl ; Pnr v

REASSIGNED: Not Applicable

**Function No. 41**

ANSI: 1B 5B 3F 34 68  
CSI ? 4 h

CUSTOM  
DEFAULT: 1B 3A  
ESC :

REASSIGNED: \_\_\_\_\_

**Function No. 42**

ANSI: 1B 5B 3F 34 6C  
CSI ? 4 I

CUSTOM  
DEFAULT: 1B 3B  
ESC ;

REASSIGNED: \_\_\_\_\_



**14.11 ENABLE ORIGIN MODE**

This sequence causes the origin (Home position) to be at the upper left character position within the margins. Refer to Section 14.7, Set Scrolling Region. Once Scrolling Region margins have been defined, the line and column numbers are relative to those margin settings. The cursor is not allowed to be positioned outside the margins.

The cursor is moved to the new Home position when this sequence is received. Lines and columns are numbered consecutively, with the origin (Home) being line 1, column 1 (upper left character position).

**14.12 DISABLE ORIGIN MODE**

This sequence causes the origin (Home position) to be at the upper left character position on the active page (column 1, line 1). If margins have been set the line and column numbers are independent of these settings. The cursor may be positioned outside the margins with a cursor position or horizontal and vertical position control.

The cursor is moved to the new Home position when this sequence is received. Lines and columns are numbered consecutively, with the origin (Home) being line 1, column 1 (upper left character position).

**14.13 WRAP ENABLE**

This sequence causes any displayable characters received when the cursor is at the right margin to advance to the beginning of the next line, performing a scroll up if required and permitted.

**14.14 WRAP DISABLE**

This sequence causes any displayable character received when the cursor is at the right margin to overwrite any previous character at this position.

**Function No. 45**

ANSI: 1B 5B 3F 36 68  
CSI ? 6 h

CUSTOM  
DEFAULT: 1B 5B 3F 36 68  
CSI ? 6 h

REASSIGNED: \_\_\_\_\_

**Function No. 46**

ANSI: 1B 5B 3F 36 6C  
CSI ? 6 I

CUSTOM  
DEFAULT: 1B 5B 3F 36 6C  
CSI ? 6 I

REASSIGNED: \_\_\_\_\_

**Function No. 47**

ANSI: 1B 5B 3F 37 68  
CSI ? 7 h

CUSTOM  
DEFAULT: 1B 33  
ESC 3

REASSIGNED: \_\_\_\_\_

**Function No. 48**

ANSI: 1B 5B 3F 37 6C  
CSI ? 7 I

CUSTOM  
DEFAULT: 1B 32  
ESC 2

REASSIGNED: \_\_\_\_\_

**14.15 NEW LINE ENABLE**

After this command has been received, any depression of the [RETURN] key will cause both the Carriage Return (CR) and Line Feed (LF) codes to be transmitted. When an LF code is received by the terminal, both a Carriage Return and a Line Feed are performed on the screen.

**14.16 NEW LINE DISABLE**

This command disables the New Line function, so that the [RETURN] key will transmit only a CR code, and receipt of the LF code will result in a Line Feed only on the screen.

**Function No. 49**

ANSI: 1B 5B 32 30 68  
CSI 2 0 h

CUSTOM  
DEFAULT: 1B 5B 32 30 68  
CSI 2 0 h

REASSIGNED: \_\_\_\_\_

**Function No. 50**

ANSI: 1B 5B 32 30 6C  
CSI 2 0 l

CUSTOM  
DEFAULT: 1B 5B 32 30 6C  
CSI 2 0 l

REASSIGNED: \_\_\_\_\_



## 15. STATUS LINE

### INTRODUCTION

The contents of the Status Line are selected by these commands. Selection is necessary, because there is not room on the Status Line to show all six Status indications at the same time.

### LIST OF COMMANDS

- 15.1 STATUS LINE ON
- 15.2 STATUS LINE OFF
- 15.3 STATUS LINE - STATUS
- 15.4 STATUS LINE - USER

### STATUS LINE

- 15.5 CURSOR POSITION ON
- 15.6 CURSOR POSITION OFF
- 15.7 TIME ON
- 15.8 TIME OFF
- 15.9 PRINTER STATUS ON
- 15.10 PRINTER STATUS OFF
- 15.11 TRANSMIT MODE ON
- 15.12 TRANSMIT MODE OFF
- 15.13 INTERFACE MONITOR ON
- 15.14 INTERFACE MONITOR OFF
- 15.15 I/O BUFFER MONITOR ON
- 15.16 I/O BUFFER MONITOR OFF
- 15.17 TERMINAL MODE ON
- 15.18 TERMINAL MODE OFF
- 15.19 LOAD USER
- 15.20 LOAD TIME

#### 15.1 STATUS LINE ON

Turns the Status Line on so that it will be displayed at the bottom of the screen.

#### Function No. 128

ANSI:           1B 5B 3F 34 30 6C  
                  CSI    ?  4  0  I

CUSTOM  
DEFAULT:       1B 5B 3F 34 30 6C  
                  CSI    ?  4  0  I

REASSIGNED: \_\_\_\_\_

**15.2 STATUS LINE OFF**

Turns the Status Line off. This is the default condition.

**Function No.** **129**

**ANSI:**        1B 5B 3F 34 30 68  
                 CSI    ? 4 0 h

**CUSTOM**

**DEFAULT:**    1B 5B 3F 34 30 68  
                 CSI    ? 4 0 h

**REASSIGNED:** \_\_\_\_\_

**15.3 STATUS LINE - STATUS**

Enables status and diagnostic information to be displayed at the bottom of the screen, as selected via the Set-up C Mode (see Section 9.6), or by the following commands.

**Function No.** **130**

**ANSI:**        1B 5B 3F 34 31 6C  
                 CSI    ? 4 1 I

**CUSTOM**

**DEFAULT:**    1B 5B 3F 34 31 6C  
                 CSI    ? 4 1 I

**REASSIGNED:** \_\_\_\_\_

**15.4 STATUS LINE - USER**

Enables user messages to be displayed at the bottom of the screen, instead of terminal status and information. Refer to Section 15.17, Load User.

**Function No.** **131**

**ANSI:**        1B 5B 3F 34 31 68  
                 CSI    ? 4 1 h

**CUSTOM**

**DEFAULT:**    1B 5B 3F 34 31 68  
                 CSI    ? 4 1 h

**REASSIGNED:** \_\_\_\_\_

**15.5 CURSOR POSITION ON**

Enables the current active cursor position to be shown on the Status Line. The cursor position is indicated by the letters P, R and C, representing page, line and column respectively. The numbering depends on the Origin Mode condition (see Sections 14.11 and 14.12).

**Function No.** **132**

**ANSI:**        1B 5B 3F 34 32 6C  
                 CSI    ? 4 2 I

**CUSTOM**

**DEFAULT:**    1B 5B 3F 34 32 6C  
                 CSI    ? 4 2 I

**REASSIGNED:** \_\_\_\_\_

**15.6 CURSOR POSITION OFF**

Removes the current cursor position information from the Status Line.

**Function No.** **133**

**ANSI:**        1B 5B 3F 34 32 68  
                 CSI    ? 4 2 h

**CUSTOM**

**DEFAULT:**    1B 5B 3F 34 32 68  
                 CSI    ? 4 2 h

**REASSIGNED:** \_\_\_\_\_

**15.7 TIME ON**

Enables the Time information to be shown on the Status Line, displayed according to the notation HH MM SS. For example 1.32 p.m. will be shown as 13 32 00. The clock is set by the Load Time Command.

**15.8 TIME OFF**

Prevents Time information from being shown on the Status Line.

**15.9 PRINTER STATUS ON**

Enables the Printer Status to be shown on the Status Line. Refer to Section 5.3

**15.10 PRINTER STATUS OFF**

Removes the Printer Status information from the Status Line.

**15.11 TRANSMIT MODE ON**

Enables the current transmission mode (Interactive or selected Block Mode - see Section 7, Fig. 13) to be displayed on the Status Line. Refer to Section 5.3

**Function No. 134**

ANSI: 1B 5B 3F 34 33 6C  
CSI ? 4 3 I

CUSTOM  
DEFAULT: 1B 5B 3F 34 33 6C  
CSI ? 4 3 I

REASSIGNED: \_\_\_\_\_

**Function No. 135**

ANSI: 1B 5B 3F 34 33 68  
CSI ? 4 3 h

CUSTOM  
DEFAULT: 1B 5B 3F 34 33 68  
CSI ? 4 3 h

REASSIGNED: \_\_\_\_\_

**Function No. 136**

ANSI: 1B 5B 3F 34 35 6C  
CSI ? 4 5 I

CUSTOM  
DEFAULT: 1B 5B 3F 34 35 6C  
CSI ? 4 5 I

REASSIGNED: \_\_\_\_\_

**Function No. 137**

ANSI: 1B 5B 3F 34 35 68  
CSI ? 4 5 h

CUSTOM  
DEFAULT: 1B 5B 3F 34 35 68  
CSI ? 4 5 h

REASSIGNED: \_\_\_\_\_

**Function No. 138**

ANSI: 1B 5B 3F 34 36 6C  
CSI ? 4 6 I

CUSTOM  
DEFAULT: 1B 5B 3F 34 36 6C  
CSI ? 4 6 I

REASSIGNED: \_\_\_\_\_

**15.12 TRANSMIT MODE OFF**

Prevents the current transmission mode from being displayed on the Status Line.

**Function No. 139**

ANSI: 1B 5B 3F 34 36 68  
CSI ? 4 6 h

**CUSTOM**

DEFAULT: 1B 5B 3F 34 36 68  
CSI ? 4 6 h

REASSIGNED: \_\_\_\_\_

**15.13 INTERFACE MONITOR ON**

Enables monitoring of the communication status in the Interface to be shown on the Status Line. Refer to Section 5.3.

**Function No. 140**

ANSI: 1B 5B 3F 34 37 6C  
CSI ? 4 7 I

**CUSTOM**

DEFAULT: 1B 5B 3F 34 37 6C  
CSI ? 4 7 I

REASSIGNED: \_\_\_\_\_

**15.14 INTERFACE MONITOR OFF**

Removes the Interface monitoring status information from the Status Line.

**Function No. 141**

ANSI: 1B 5B 3F 34 37 68  
CSI ? 4 7 h

**CUSTOM**

DEFAULT: 1B 5B 3F 34 37 68  
CSI ? 4 7 h

REASSIGNED: \_\_\_\_\_

**15.15 I/O BUFFER MONITOR ON**

Enables a graphic indication of the I/O Buffer level to be shown on the Status Line. Refer to Section 5.3.

**Function No. 142**

ANSI: 1B 5B 3F 34 38 6C  
CSI ? 4 8 I

**CUSTOM**

DEFAULT: 1B 5B 3F 34 38 6C  
CSI ? 4 8 I

REASSIGNED: \_\_\_\_\_

**15.16 I/O BUFFER MONITOR OFF**

Removes the I/O Buffer monitoring information from the Status Line.

**Function No. 143**

ANSI: 1B 5B 3F 34 38 68  
CSI ? 4 8 h

**CUSTOM**

DEFAULT: 1B 5B 3F 34 38 68  
CSI ? 4 8 h

REASSIGNED: \_\_\_\_\_

**15.17 TERMINAL MODE ON**

Enables an indication to be displayed on the status line of whether the terminal is in the Insert Mode or Replacement Mode, and if the keypad is set for Numeric or Application Mode.

**Function No. N/a**

ANSI:           1B 5B 3F 34 39 6C  
                  CSI    ?  4  9  I

CUSTOM  
DEFAULT:       1B 5B 3F 34 39 6C  
                  CSI    ?  4  9  I

REASSIGNED: Not Applicable

**15.18 TERMINAL MODE OFF**

Removes the terminal mode information from the status line.

**Function No. N/a**

ANSI:           1B 5B 3F 34 39 68  
                  CSI    ?  4  9  h

CUSTOM  
DEFAULT:       1B 5B 3F 34 39 68  
                  CSI    ?  4  9  h

REASSIGNED: Not Applicable

**15.19 LOAD USER**

When Set-up Mode Switch C.3.1. ("Status Line - User/Status") is set to "User" (see Section 9.6) this command sequence will enable the User Status Line to be loaded with the desired message.

The message text of maximum 80 characters, can include character attributes, by using the usual commands (excluding double width and double size). If the message is shorter than 80 characters, it is terminated with CR (Hex 0D).

The User line can be loaded regardless of whether the Status line is enabled or disabled (Set-up Mode Switch B.3.2.).

Note: The User line message will be erased as soon as "Status line - Terminal Mode" is enabled by switch C.3.1.

**Function No. 148**

ANSI:           1B 5B 3F 4C  
                  CSI    ?  L

CUSTOM  
DEFAULT:       1B 5B 3F 4C  
                  CSI    ?  L

REASSIGNED: \_\_\_\_\_

**15.20 LOAD TIME**

If Time is selected to be displayed on the Status Line, the figures must be set according to the current time. This is done using the notation HH MM SS where for example 1.32 p.m. is entered as 13 32 00.

**Function No. N/a**

ANSI:           1B 5B 3F Ph 3B Pm 54  
                  CSI    ? Ph ; Pm T

CUSTOM  
DEFAULT:       1B 5B 3F Ph 3B Pm 54  
                  CSI    ? Ph ; Pm T

REASSIGNED: Not Applicable





## 16. MULTIPAGE HANDLING

### INTRODUCTION

These commands determine how the terminal will partition the available internal memory, and in the case of the Flip Page Mode, how to change the active page.

#### 16.1 SELECT FLIP PAGE MODE

This sequence sets the terminal to Flip Page Mode, i.e. three 24-line pages, each page acting independently of the other two. This is the default condition. When the Select Flip Page Mode command is received the cursor moves to 'Super Home', which is page 1, line 1, column 1.

#### 16.2 SELECT BIG PAGE MODE

This sequence sets the terminal to Big Page Mode, i.e. one 72 line page. On receipt of this command the cursor moves to 'Super Home', which is page 1, line 1, column 1.

#### 16.3 ADVANCE PAGES

Selects which page will be displayed next when the terminal is set for Flip Page operation. If the parameter Pn is 0 or 1 or omitted the display is advanced to show the next page, e.g. if Page 2 is already displayed as the active page, Page 3 will become the active page on receipt of this command with parameter 0, 1 or no parameter.

If the parameter Pn is 2 or 3 the next but one page becomes the active page. This will only apply if Page 1 is the current active page, because no advancement is possible beyond Page 3.

If the terminal is in Big Page Mode the command is ignored.

### LIST OF COMMANDS

- 16.1 SELECT FLIP PAGE MODE
- 16.2 SELECT BIG PAGE MODE
- 16.3 ADVANCE PAGES
- 16.4 BACK PAGES

#### Function No. 83

ANSI: 1B 5B 3F 33 31 6C  
CSI ? 3 1 I

CUSTOM  
DEFAULT : 1B 5B 3F 33 31 6C  
CSI ? 3 1 I

REASSIGNED: \_\_\_\_\_

#### Function No. 84

ANSI: 1B 5B 3F 33 31 68  
CSI ? 3 1 h

CUSTOM  
DEFAULT: 1B 5B 3F 33 31 68  
CSI ? 3 1 h

REASSIGNED: \_\_\_\_\_

#### Function No. 85

ANSI: 1B 5B (Pn) 55  
CSI (Pn) U

CUSTOM  
DEFAULT: 1B 75  
ESC u

REASSIGNED: \_\_\_\_\_

**16.4 BACK PAGES**

Selects display of previous pages when the terminal is set for Flip Page operation. If the parameter Pn is 0 or 1 or omitted the display shows the next previous page, e.g. if Page 3 is already displayed as the active page, Page 2 will become the active page on receipt of this command with parameter 0, 1 or no parameter.

If the parameter Pn is 2 or 3 the next but one previous page becomes the active page. This will only apply if Page 3 is the current active page, because no retreat is possible beyond Page 1.

If the terminal is in Big Page Mode the command is ignored.

**Function No.****86**

**ANSI:**           1B 5B (Pn) 56  
                  CSI   (Pn)  V

**CUSTOM**

**DEFAULT:**       1B 76  
                  ESC  v

**REASSIGNED:** \_\_\_\_\_

## 17. KEYBOARD FUNCTIONS

### INTRODUCTION

These commands are concerned with keyboard locking, Keypad Application or Numeric Mode, Cursor Keys Application or Cursor Mode, auto-repeat and the programmable LEDs.

### LIST OF COMMANDS

- 17.1 KEYBOARD LOCK
- 17.2 KEYBOARD UNLOCK
- 17.3 AUTO-REPEAT ON
- 17.4 AUTO-REPEAT OFF
- 17.5 KEYPAD NUMERIC MODE
- 17.6 KEYPAD APPLICATION MODE
- 17.7 CURSOR KEYS - APPLICATION
- 17.8 CURSOR KEYS - CURSOR
- 17.9 LOAD PROGRAMMABLE LEDs
- 17.10 FLASH LEDs
- 17.11 EXTINGUISH ALL LEDs
- 17.12 LIGHT LED 1
- 17.13 LIGHT LED 2
- 17.14 LIGHT LED 3
- 17.15 LIGHT LED 4

#### 17.1 KEYBOARD LOCK

The Keyboard Lock command disables the keyclick and all keyboard functions. Subsequent key strokes will be ignored until the Keyboard Unlock code is received from the host.

#### 17.2 KEYBOARD UNLOCK

The Keyboard Unlock command is the reverse function to Keyboard Lock and frees the keys to perform their normal functions.

#### Function No. 53

ANSI:           1B 5B 32 68  
                  CSI     2  h

CUSTOM  
DEFAULT:       1B 66  
                  ESC f

REASSIGNED: \_\_\_\_\_

#### Function No. 54

ANSI:           1B 5B 32 6C  
                  CSI     2  l

CUSTOM  
DEFAULT:       1B 65  
                  ESC e

REASSIGNED: \_\_\_\_\_

**17.3 AUTO-REPEAT ON**

All keys on the keyboard, except [SET UP], [BREAK], [ESCAPE], [NO SCROLL], [ALPHA TAB], [RETURN] and [ENTER] will repeat when this command is received.

**Function No. 55**

ANSI: 1B 5B 3F 38 68  
CSI ? 8 h

CUSTOM  
DEFAULT: 1B 5B 3F 38 68  
CSI ? 8 h

REASSIGNED: \_\_\_\_\_

**17.4 AUTO-REPEAT OFF**

This function prevents any key on the keyboard from auto-repeating.

**Function No. 56**

ANSI: 1B 5B 3F 38 6C  
CSI ? 8 I

CUSTOM  
DEFAULT: 1B 5B 3F 38 6C  
CSI ? 8 I

REASSIGNED: \_\_\_\_\_

**17.5 KEYPAD NUMERIC MODE**

The keys in the numeric block will send ASCII codes according to the characters on the keytops. This is the default condition.

**Function No. 57**

ANSI: 1B 3E  
ESC >

CUSTOM  
DEFAULT: 1B 3E  
ESC >

REASSIGNED: \_\_\_\_\_

**17.6 KEYPAD APPLICATION MODE**

The numeric keypad keys will transmit code sequences as defined in Section 8.3.2, Transmitted Codes.

**Function No. 58**

ANSI: 1B 3D  
ESC =

CUSTOM  
DEFAULT: 1B 3D  
ESC =

REASSIGNED: \_\_\_\_\_

**17.7 CURSOR KEYS - APPLICATION**

This command enables the Cursor Control keys to provide the Application codes as listed in Section 8.3.2.

**Function No. N/a**

ANSI: 1B 5B 3F 31 68  
CSI ? 1 h

CUSTOM  
DEFAULT: Not applicable

REASSIGNED: Not applicable

17.8 CURSOR KEYS - CURSOR

This function returns the Cursor Control keys to provide their normal codes, as listed in Section 8.3.2. This is the default condition.

Function No. N/a

ANSI: 1B 5B 3F 31 6C  
CSI ? 1 I

CUSTOM  
DEFAULT: Not applicable

REASSIGNED: Not applicable

17.9 LOAD PROGRAMMABLE LEDs

Loads the four programmable LEDs on the keyboard according to the selected parameter(s).

Function No. N/a

ANSI: 1B 5B Ps 3B Ps ...3B 71  
CSI Ps ; Ps ... ; q

PARAMETER (Ps)	PARAMETER MEANING
0	Clear LEDs L1 to L4
1	Light L1
2	Light L2
3	Light L3
4	Light L4

CUSTOM  
DEFAULT: Not applicable

REASSIGNED: Not applicable

The LED numbers are shown on the keyboard.

17.10 FLASH LEDs

This function will start the LEDs flashing according to the selected parameter(s).

Function No. 61

ANSI: 1B 5B 3F Ps 3B Ps 3B....74  
CSI ? Ps ; Ps ;.... t

PARAMETER (Ps)	PARAMETER MEANING
0	Stop flashing of all LEDs
1	Flash L1
2	Flash L2
3	Flash L3
4	Flash L4

CUSTOM  
DEFAULT: None

REASSIGNED: \_\_\_\_\_

The selected LED(s) will start flashing regardless of its state (lit or unlit).

In Custom Mode the function is defined as follows,  
<Command> <Final Character> Ps.

e.g. Flash LED 1

1B 74 31  
ESC t 1

**17.11 EXTINGUISH ALL LEDs**

Any LEDs which have been lit up to the receipt of this command will now be extinguished.

**Function No.** 64

ANSI: 1B 5B 30 71  
CSI 0 q

CUSTOM  
DEFAULT: 1B 5B 30 71  
CSI 0 q

REASSIGNED: \_\_\_\_\_

**17.12 LIGHT LED 1**

Lights LED 1.

**Function No.** 65

ANSI: 1B 5B 31 71  
CSI 1 q

CUSTOM  
DEFAULT: 1B 5B 31 71  
CSI 1 q

REASSIGNED: \_\_\_\_\_

**17.13 LIGHT LED 2**

Lights LED 2.

**Function No.** 66

ANSI: 1B 5B 32 71  
CSI 2 q

CUSTOM  
DEFAULT: 1B 5B 32 71  
CSI 2 q

REASSIGNED: \_\_\_\_\_

**17.14 LIGHT LED 3**

Lights LED 3.

**Function No.** 67

ANSI: 1B 5B 33 71  
CSI 3 q

CUSTOM  
DEFAULT: 1B 5B 33 71  
CSI 3 q

REASSIGNED: \_\_\_\_\_

**17.15 LIGHT LED 4**

Lights LED 4.

**Function No.** 68

ANSI: 1B 5B 34 71  
CSI 4 q

CUSTOM  
DEFAULT: 1B 5B 34 71  
CSI 4 q

REASSIGNED: \_\_\_\_\_

# 18. EDITING FUNCTIONS

## INTRODUCTION

Text editing functions, such as deletion and insertion of characters, words and lines, are covered by these commands.

## LIST OF COMMANDS

- 18.1 ERASURE MODE - UNPROT. ONLY
- 18.2 ERASURE MODE - ALL
- 18.3 ERASE IN DISPLAY
- 18.4 ERASE IN LINE
- 18.5 HOME AND CLEAR
- 18.6 DELETE CHARACTER
- 18.7 DELETE WORD
- 18.8 DELETE LINE
- 18.9 INSERT LINE
- 18.10 ENTER INSERTION MODE
- 18.11 EXIT INSERTION MODE
- 18.12 ERASE PAGE
- 18.13 ERASE LINE

### 18.1 ERASURE MODE - UNPROTECTED ONLY

When this function is enabled, the Erase in Display, Erase in Line, Home and Clear (Functions 71, 72, 73 and 74) commands do not erase protected data.

### 18.2 ERASURE MODE - ALL

When this function is enabled, the Erase in Display and Erase in Line commands (Functions 71, 72, 73 and 74) erase any data regardless of protection.

### Function No. 69

ANSI:           1B 5B 36 6C  
                  CSI     6 I

CUSTOM  
DEFAULT:       1B 5B 36 6C  
                  CSI     6 I

REASSIGNED: \_\_\_\_\_

### Function No. 70

ANSI:           1B 5B 36 68  
                  CSI     6 h

CUSTOM  
DEFAULT:       1B 5B 36 68  
                  CSI     6 h

REASSIGNED: \_\_\_\_\_



**18.3 ERASE IN DISPLAY**

This sequence erases some or all of the characters in the display as determined by the parameter Ps. Any complete line erased by the sequence will return that line to single width mode.

PARAMETER (Ps)	PARAMETER MEANING
0	Erase from the cursor position to the end of the screen (default and Custom Default functions).
1	Erase from the start of the screen up to and including the cursor position.
2	Erase all of the display - every line is erased and changed to single width. The cursor does not move.

**18.4 ERASE IN LINE**

This sequence erases some or all of the characters in the active line, as set by the parameter Ps.

PARAMETER (Ps)	PARAMETER MEANING
0	Erase from the cursor position to the end of the line (default and Custom Default functions).
1	Erase from the start of the line up to and including the cursor position.
2	Erase complete line.

**18.5 HOME AND CLEAR**

The screen or screen memory is cleared and the cursor is moved to the Home position on the active page, or the Super Home position if the 'All Pages' function is required.

PARAMETER (Ps)	PARAMETER MEANING
0	The page containing the cursor is cleared (Default).
1	All three pages are cleared, i.e. the screen memory is cleared.

**Function No. 71**

**ANSI:** 1B 5B Ps 4A  
CSI Ps J

**CUSTOM**  
**DEFAULT:** 1B 4A (= Ps 0)  
ESC J

**REASSIGNED:** \_\_\_\_\_

**Function No. 72**

**ANSI:** 1B 5B Ps 4B  
CSI Ps K

**CUSTOM**  
**DEFAULT:** 1B 4B (= Ps 0)  
ESC K

**REASSIGNED:** \_\_\_\_\_

**Function No. 73 & 74**

**ANSI:** 1B 5B Ps 58  
CSI Ps X

**CUSTOM**  
**DEFAULT:** 1B 4C (= Ps 0) (73)  
ESC L

**CUSTOM**  
**DEFAULT:** 1B 58 (= Ps 1) (74)  
ESC X

**REASSIGNED:** \_\_\_\_\_ (= Ps 0) (73)

**REASSIGNED:** \_\_\_\_\_ (= Ps 1) (74)

**18.6 DELETE CHARACTER**

Deletes Pn characters on a single line, starting with the character at the cursor position. Any characters remaining on the line to the right of the deleted character will be moved Pn spaces left, to fill the gap created by the deletion.

**Function No. 75**

ANSI: 1B 5B Pn 50  
CSI Pn P

CUSTOM  
DEFAULT: 1B 22  
ESC "

REASSIGNED: \_\_\_\_\_

**18.7 DELETE WORD**

Deletes the word denoted by the cursor according to the following.

- (1) A word is defined as a string of characters (Hex 21 to Hex 7E) starting with either a space or left margin and terminated by a space, right margin or a punctuation mark (Hex 21, 2C, 2E, 3A, 3B, or 3F) followed by a space.
- (2) To delete a word position the cursor on any character within the word, but not on the lead-in space or trailing word terminator.
- (3) When the word has been deleted, the cursor is positioned to the first position right of the trailing word terminator. Any characters remaining on the line to the right of the deleted word are moved a corresponding number of places left, to fill the gap created by deleting the word.

**Function No. 76**

ANSI: 1B 5B 57  
CSI W

CUSTOM  
DEFAULT: 1B 4D  
ESC M

REASSIGNED: \_\_\_\_\_

**18.8 DELETE LINE**

Deletes Pn complete lines from the display, starting with the line which contains the cursor. Any lines within the scrolling region remaining below the deletion are moved up by Pn lines to occupy the space caused by the deletion. The blank lines thus created at the bottom of the scrolling region are filled with "all attributes off" for the bottom of the scrolling region.

**Function No. 77**

ANSI: 1B 5B Pn 4D  
CSI Pn M

CUSTOM  
DEFAULT: 1B 55  
ESC U

REASSIGNED: \_\_\_\_\_

**18.9 INSERT LINE**

Creates a blank area of Pn lines in the scrolling region by moving all text at and below the cursor line down by Pn lines. The blank lines are filled with "all attributes off" of the original cursor line.

**Function No. 78**

ANSI: 1B 5B Pn 4C  
CSI Pn L

CUSTOM  
DEFAULT: 1B 54  
ESC T

REASSIGNED: \_\_\_\_\_

**18.10 ENTER INSERTION MODE**

This command causes the terminal to enter the Insertion Mode. Each new insert character received is displayed at the cursor position and all characters from the cursor position to the right margin are shifted one place to the right; the right-most character is lost. Whether the Insertion Mode is Set or Reset can be selected to be displayed on the Status Line.

**Function No.** 79

**ANSI:** 1B 5B 34 68  
CSI 4 h

**CUSTOM**  
**DEFAULT:** 1B 21  
ESC !

**REASSIGNED:** \_\_\_\_\_**18.11 EXIT INSERTION MODE**

This command causes the terminal to exit the Insertion Mode and enter the Replacement Mode (the default condition). In this case the new character is written over the existing character at the cursor position and replaces it. Whether the Insertion Mode is Set or Reset can be selected to be displayed on the Status Line.

**Function No.** 80

**ANSI:** 1B 5B 34 6C  
CSI 4 I

**CUSTOM**  
**DEFAULT:** 1B  
CAN

**REASSIGNED:** \_\_\_\_\_**18.12 ERASE PAGE**

Erase all of the display, every line is erased and changed to single width. The cursor does not move.

**Function No.** 81**ANSI:** Not Applicable

**CUSTOM**  
**DEFAULT:** None

**REASSIGNED:** \_\_\_\_\_**18.13 ERASE LINE**

Erases the complete line. The cursor does not move.

**Function No.** 82**ANSI:** Not Applicable

**CUSTOM**  
**DEFAULT:** None

**REASSIGNED:** \_\_\_\_\_

## 19. CHARACTER AND LINE ATTRIBUTES

### INTRODUCTION

These commands consist of a comprehensive set of control functions which determine the size and width of the characters on the screen, their attributes such as bold, blinking etc., whether they will be displayed or held in a security field, and which character set they will be drawn from.

### LIST OF COMMANDS

- 19.1 DOUBLE SIZE LINE
- 19.2 SINGLE-WIDTH LINE
- 19.3 DOUBLE-WIDTH LINE
- 19.4 SELECT VIDEO ATTRIBUTES - ANSI
- 19.5 SELECT VIDEO ATTRIBUTES  
- CUSTOM
- 19.6 START BOLD INTENSITY
- 19.7 END BOLD INTENSITY
- 19.8 START BLINKING
- 19.9 END BLINKING
- 19.10 START REVERSE VIDEO
- 19.11 END REVERSE VIDEO
- 19.12 START UNDERLINE
- 19.13 END UNDERLINE
- 19.14 UNDERLINE CURRENT CHARACTER
- 19.15 START SECURITY FIELD
- 19.16 END SECURITY FIELD
- 19.17 SELECT CHARACTER SET
- 19.17.1 SELECT CHARACTER CODES - ANSI
- 19.18 SELECT CHARACTER SET - CUSTOM
- 19.18.1 ENTER SEMIGRAPHS
- 19.18.2 EXIT SEMIGRAPHS
- 19.18.3 SELECT ALTERNATE CHARACTER  
GENERATOR
- 19.18.4 SELECT STANDARD CHARACTER  
GENERATOR

### 19.1 DOUBLE SIZE LINE

The line containing the cursor becomes the top or bottom half of a double-height, double-width line, as determined by the control sequences. In order to ensure full double size characters, the control sequences must be used in pairs on adjacent lines, and the same character output must be sent to both lines. If the line was single-width, single-height, all characters to the right of the centre of the screen are lost. If the cursor is located to the left of the screen centre, it will remain in the same character position; if the cursor is to the right of the screen centre, it is moved to the right margin.

If the Terminal is in the **Portrait Display Mode** the line attributes are stored and displayed in the form AA rather than **A**  
AA

When the screen is "Twisted" into **Landscape Mode** the line attributes are executed, and vice versa.

### 19.2 SINGLE-WIDTH LINE

This sequence causes the line containing the cursor to become single-width, single-height. The cursor remains at the same character position; this is the default condition for all new lines on the screen.

### 19.3 DOUBLE-WIDTH LINE

This sequence causes the line that contains the cursor to become double-width, single-height; all characters to the right of the screen centre are lost. If the cursor is located to the left of the screen centre, it will remain in the same character position; if the cursor is to the right of the screen centre, it is moved to the right margin.

If the Terminal is in the **Portrait Display Mode** the line attributes are stored and displayed in the form AA rather than **A**.

When the screen is "Twisted" into **Landscape Mode** the line attributes are executed, and vice versa.

### Function No. 89 & 90

ANSI: Top Half 1B 23 33 (89)  
ESC # 3

Bottom Half 1B 23 34 (90)  
ESC # 4

CUSTOM  
DEFAULT: Top Half 1B 23 33 (89)  
ESC # 3

Bottom Half 1B 23 34 (90)  
ESC # 4

REASSIGNED: \_\_\_\_\_ (89)

\_\_\_\_\_ (90)

### Function No. 91

ANSI: 1B 23 35  
ESC # 5

CUSTOM  
DEFAULT: 1B 23 35  
ESC # 5

REASSIGNED: \_\_\_\_\_

### Function No. 92

ANSI: 1B 23 36  
ESC # 6

CUSTOM  
DEFAULT: 1B 23 36  
ESC # 6

REASSIGNED: \_\_\_\_\_

**19.4 SELECT VIDEO ATTRIBUTES - ANSI**

This sequence enables the video attributes as specified by the parameter or parameters. All characters transmitted to the terminal following the sequence are displayed according to the specified parameters until the next occurrence of a Select Video Attributes sequence.

PARAMETER (Ps)	PARAMETER MEANING
0	Attribute off (Default)
1	Bold (increased intensity)
4	Underline
5	Blink
7	Negative (reverse) video

All other parameter values are ignored.

**Function No.** \_\_\_\_\_ **N/a**

**ANSI:**            1B 5B Ps 3B Ps 3B Ps 6D  
                     CSI Ps ; Ps ; Ps m

**CUSTOM**

**DEFAULT:**      Not Applicable

**REASSIGNED:** Not Applicable

**19.5 SELECT VIDEO ATTRIBUTES - CUSTOM**

Ps Hex	INTENSITY	BLINK	REVERSE	UNDERLINE
40	INCREASED	NO	NO	NO
41	INCREASED	NO	NO	YES
42	INCREASED	NO	YES	NO
43	INCREASED	NO	YES	YES
44	INCREASED	YES	NO	NO
45	INCREASED	YES	NO	YES
46	INCREASED	YES	YES	NO
47	INCREASED	YES	YES	YES
48	STANDARD	NO	NO	NO
49	STANDARD	NO	NO	YES
4A	STANDARD	NO	YES	NO
4B	STANDARD	NO	YES	YES
4C	STANDARD	YES	NO	NO
4D	STANDARD	YES	NO	YES
4E	STANDARD	YES	YES	NO
4F	STANDARD	YES	YES	YES

**Function No.** \_\_\_\_\_ **95**

**ANSI:**            Not Applicable

**CUSTOM**

**DEFAULT:**      1B 53 Ps  
                     ESC S Ps

**REASSIGNED:** \_\_\_\_\_

**19.6 START BOLD INTENSITY**

After this function code, all subsequent data received by the terminal is displayed with bold intensity.

**Function No.** 96

**ANSI:** Not Applicable

**CUSTOM**  
**DEFAULT:** 1B 2C  
ESC ,

**REASSIGNED:** \_\_\_\_\_

**19.7 END BOLD INTENSITY**

This is the reverse of the Start Bold Intensity sequence, see above.

**Function No.** 97

**ANSI:** Not Applicable

**CUSTOM**  
**DEFAULT:** 1B 2B  
ESC +

**REASSIGNED:** \_\_\_\_\_

**19.8 START BLINKING**

Displayable characters received after these codes will blink.

**Function No.** 98

**ANSI:** Not Applicable

**CUSTOM**  
**DEFAULT:** 1B 29  
ESC )

**REASSIGNED:** \_\_\_\_\_

**19.9 END BLINKING**

This is the reverse of the START BLINKING sequence, see above.

**Function No.** 99

**ANSI:** Not Applicable

**CUSTOM**  
**DEFAULT:** 1B 2A  
ESC \*

**REASSIGNED:** \_\_\_\_\_

**19.10 START REVERSE VIDEO**

After this function code, all subsequent displayable characters will be displayed in reverse video against the selected screen background.

**Function No.** 100

**ANSI:** Not Applicable

**CUSTOM**  
**DEFAULT:** 1B 27  
ESC '

**REASSIGNED:** \_\_\_\_\_

**19.11 END REVERSE VIDEO**

This is the reverse of the START REVERSE VIDEO sequence, see above.

**Function No.** 101

**ANSI:** Not Applicable

**CUSTOM**  
**DEFAULT:** 1B 28  
ESC (

**REASSIGNED:** \_\_\_\_\_

**19.12 START UNDERLINE**

After this function code, all subsequent displayable characters will be underlined.

**Function No.** 102

**ANSI:** Not Applicable

**CUSTOM**  
**DEFAULT:** 1B 25  
ESC %

**REASSIGNED:** \_\_\_\_\_

**19.13 END UNDERLINE**

This is the reverse of the START UNDERLINE sequence, see above.

**Function No.** 103

**ANSI:** Not Applicable

**CUSTOM**  
**DEFAULT:** 1B 26  
ESC &

**REASSIGNED:** \_\_\_\_\_

**19.14 UNDERLINE CURRENT CHARACTER**

The character at the cursor position is underlined regardless of the state of the other video attributes. The cursor moves to the right after underlining.

**Function No.** 104

**ANSI:** Not Applicable

**CUSTOM**  
**DEFAULT:** 1B 2D  
ESC -

**REASSIGNED:** \_\_\_\_\_

**19.15 START SECURITY FIELD**

Displayable characters received after this command will not be displayed, but will otherwise be treated as normal characters.

**Function No.** 105

**ANSI:** 1B 5B 31 73  
CSI 1 s

**CUSTOM**  
**DEFAULT:** 1B 5B 31 73  
CSI 1 s

**REASSIGNED:** \_\_\_\_\_



**19.16 END SECURITY FIELD**

Function No.

This is the reverse of the START SECURITY FIELD sequence, see above.

ANSI:           1B 5B 30 73  
                  CSI    0 s

CUSTOM  
DEFAULT:       1B 5B 30 73  
                  CSI    0 s

REASSIGNED: \_\_\_\_\_

**19.17 SELECT CHARACTER SET - ANSI**

The required G0 and G1 character sets are selected from one of the two (or four) possible character sets by the sequences given here. Once the G0 and G1 sets have been selected, the G0 character set is enabled by the Hex Code 0F (Shift In) and the G1 character set is enabled by Hex Code 0E (Shift Out).

Special Graphics means that the characters for the codes Hex 5F to Hex 7E are replaced with other symbols when displayed.

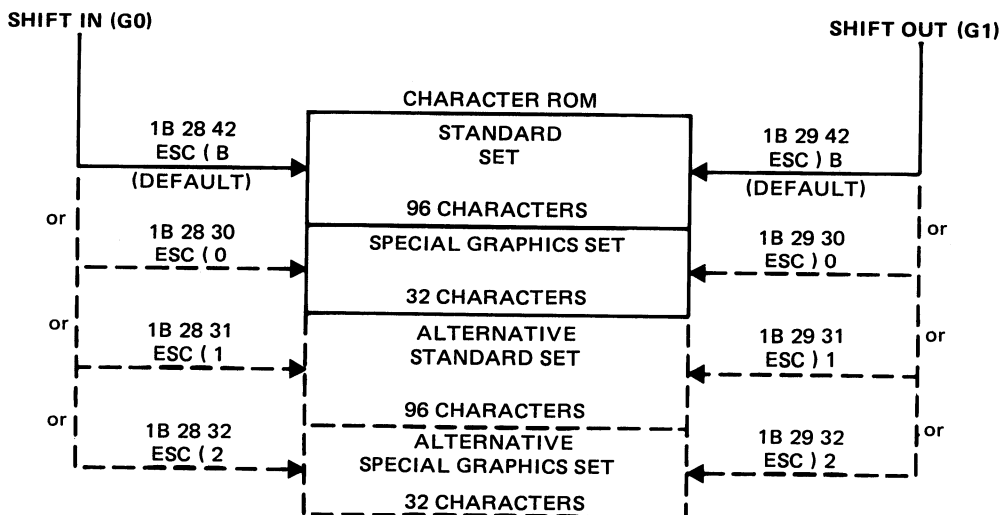

Fig.31 ANSI Character Set Selection

19.17.1 SELECT CHARACTER CODES - ANSI

Function No.

N/a

CHARACTER SET	SELECT AS G0 SET (Shift In)	SELECT AS G1 SET (Shift Out)
Standard set, 96 characters.	1B 28 42 ESC ( B	1B 29 42 ESC ) B
Special graphics, 32 characters, as shown in Appendix 5.	1B 28 30 ESC ( 0	1B 29 30 ESC ) 0
*Alternative character ROM. Standard set, 96 characters.	1B 28 31 ESC ( 1	1B 29 31 ESC ) 1
*Alternative character ROM. Special graphics, 32 characters/ symbols, as shown in Appendix 5.	1B 28 32 ESC ( 2	1B 29 32 ESC ) 2

\*Option

19.18 SELECT CHARACTER SET - CUSTOM

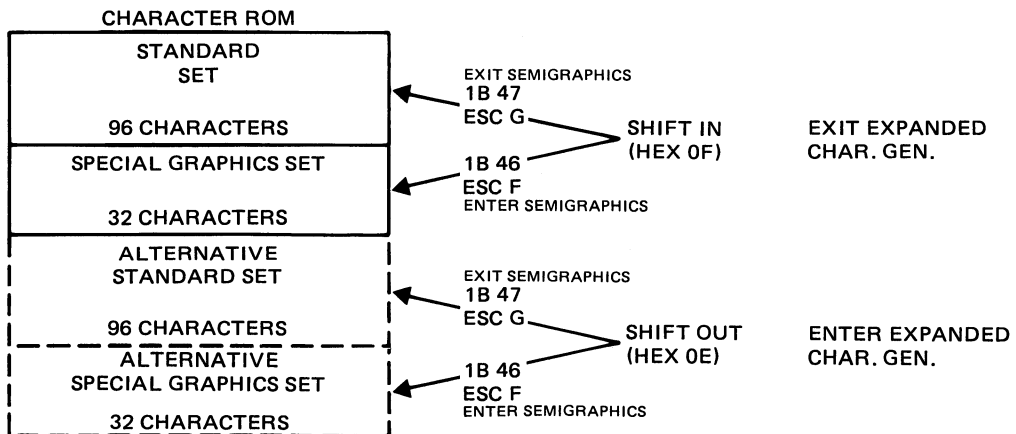

Fig.32 Custom Character Set Selection

**19.18.1 ENTER SEMIGRAPHICS**

This function invokes an alternative Semigraphic character set for ASCII codes Hex 5E to Hex 7E inclusive. Same as "Special Graphics" in the ANSI Command Set.

**Function No.** 122**ANSI:** Not Applicable

**CUSTOM**  
**DEFAULT:** 1B 46  
 ESC F

**REASSIGNED:** \_\_\_\_\_**19.18.2 EXIT SEMIGRAPHICS**

This will exit the Semigraphic Mode and restore the standard character set.

**Function No.** 123**ANSI:** Not Applicable

**CUSTOM**  
**DEFAULT:** 1B 47  
 ESC G

**REASSIGNED:** \_\_\_\_\_**19.18.3 SELECT ALTERNATE CHAR GENERATOR**

\*Invokes an optional expanded character set. If entered from Function 122 an additional 32 character set is available, whilst from Function 123 (default) 96 additional characters are available.

**Function No.** 124**ANSI:** Not Applicable

**CUSTOM**  
**DEFAULT:** 0E  
 S0

**REASSIGNED:** \_\_\_\_\_**19.18.4 SELECT STANDARD CHAR GENERATOR**

\*Shifts back to the corresponding standard part of the character generator.

\*Option

**Function No.** 125**ANSI:** Not Applicable

**CUSTOM**  
**DEFAULT:** 0F  
 S1

**REASSIGNED:** \_\_\_\_\_

## 20. FORMAT MODE

### INTRODUCTION

These functions are concerned with the formation of protected fields so that the screen data will consist of protected and unprotected fields. The difference between the two is normally shown by using a different video attribute for each. Full details of the Format Mode function are given in Section 7.4.

### LIST OF COMMANDS

- 20.1 ENTER PROTECTION MODE - CUSTOM
- 20.2 FORMAT MODE - ANSI  
PROTECTED ATTRIBUTES
- 20.3 EXIT PROTECTION MODE  
- CUSTOM & ANSI
- 20.4 BOLD PROTECTED
- 20.5 UNDERLINE PROTECTED
- 20.6 BLINK PROTECTED
- 20.7 REVERSE VIDEO PROTECTED
- 20.8 ALL ATTRIBUTES OFF PROTECTED
- 20.9 BLANK PROTECTED
- 20.10 RESET CUSTOM PROTECTED  
ATTRIBUTES

#### 20.1 ENTER PROTECTION MODE - CUSTOM

This sequence selects the Format Mode, in which the cursor is prevented from entering protected fields. The cursor goes to the first unprotected position on the screen. Protected fields are usually indicated by the using the Normal intensity attribute; unprotected fields are then emphasised by use of the Bold attribute. To select the protected attributes, either use the Custom Mode Set- Up 4 switches or one of the functions 110 to 115 as appropriate

#### 20.2 FORMAT MODE - ANSI PROTECTED ATTRIBUTES

Selection of a video attribute also means that the Format Mode is entered. The attributes required to show protected fields on the screen are selected by this function, using the appropriate parameters as listed below.

PARAMETER (Ps)	PROTECTION
1	Bold
4	Underlined
5	Blinking
7	Reverse Video
254	All Attributes Off

#### Function No. 108

ANSI: Not Applicable

CUSTOM  
DEFAULT: 1B 2E  
ESC .

REASSIGNED: \_\_\_\_\_

#### Function No. N/a

ANSI: 1B 5B Ps 7D  
CSI Ps J

CUSTOM  
DEFAULT: Not Applicable

REASSIGNED: Not Applicable

**20.3 EXIT PROTECTED MODE - CUSTOM & ANSI**

This sequence deselects the Format Mode, so that cursor positioning is unrestricted.

**Function No.** 109

ANSI: 1B 5B 30 7D  
CSI 0 }

CUSTOM  
DEFAULT: 1B 2F  
ESC /

REASSIGNED: \_\_\_\_\_

**20.4 BOLD PROTECTED**

This function selects the Bold video attribute to show that the field is protected when in the Format Mode.

**Function No.** 110

ANSI: 1B 5B 31 7D  
CSI 1 }

CUSTOM  
DEFAULT: 1B 5B 31 7D  
CSI 1 }

REASSIGNED: \_\_\_\_\_

**20.5 UNDERLINE PROTECTED**

This function selects the Underlined video attribute to show that the field is protected when in the Format Mode.

**Function No.** 111

ANSI: 1B 5B 34 7D  
CSI 4 }

CUSTOM  
DEFAULT: 1B 5B 34 7D  
CSI 4 }

REASSIGNED: \_\_\_\_\_

**20.6 BLINK PROTECTED**

This function selects the Blink video attribute to show that the field is protected when in the Format Mode.

**Function No.** 112

ANSI: 1B 5B 35 7D  
CSI 5 }

CUSTOM  
DEFAULT: 1B 5B 35 7D  
CSI 5 }

REASSIGNED: \_\_\_\_\_

**20.7 REVERSE VIDEO PROTECTED**

This function selects the Reverse video attribute to show that the field is protected when in the Format Mode.

**Function No.** 113

ANSI: 1B 5B 37 7D  
CSI 7 }

CUSTOM  
DEFAULT: 1B 5B 37 7D  
CSI 7 }

REASSIGNED: \_\_\_\_\_

**20.8 ALL ATTRIBUTES OFF PROTECTED**

This function ensures that characters which have no video attributes are protected in the Format Mode, i.e. any character which has a video attribute such as Bold, Underlined etc. will not be protected.

**Function No. 114**

ANSI: 1B 5B 32 35 34 7D  
CSI 2 5 4 }

CUSTOM  
DEFAULT: 1B 5B 32 35 34 7D  
CSI 2 5 4 }

REASSIGNED: \_\_\_\_\_

**20.9 BLANK PROTECTED**

This function selects the blank video attribute to show that the field is protected when in the Format Mode.

**Function No. 115**

ANSI: Not Applicable

CUSTOM  
DEFAULT: None

REASSIGNED: \_\_\_\_\_

**20.10 RESET CUSTOM PROTECTED ATTRIBUTES**

This function sets all protected attributes to unprotected attributes. However the Format Mode will still be selected.

**Function No. 116**

ANSI: Not Applicable

CUSTOM  
DEFAULT: None

REASSIGNED: \_\_\_\_\_

SUMMARY OF SET AND RESET PART I PARAMETERS

PARAMETER (Ps)	MODE FUNCTION	SET	RESET
1	Cursor key	Application Functions	Cursor Control
2	Command Mode	Not Applicable	Custom
4	Scrolling	Smooth	Jump
5	Screen	Reverse	Normal
6	Origin	Margins	Home
7	Auto Wrap	Wrap	No Wrap
8	Auto Repeat	Repeat	No Repeat
10	Send Mode Remote Change	Block	Character Mode
11	Send Extent	Line	Page/Block
13	Space Comp.	On	Off
14	Request Send	Local	Remote Initiate
31	Select Multi-page Mode	1 * 72	3 * 24
32	Scroll-Mode	Page	Scroll
35	Cursor On/Off	Off	On
36	Screen On/Off	Off	On
<b>Status Line</b>			
40	Status Line On/Off	Off	On
41	Status Line User/Status	User Line	Status Line
42	Status Line Cursor Posn	Off	On
43	Time	Off	On
44	Reserved	Off	On
45	Print Status	Off	On
46	Transmission Mode	Off	On
47	Interface Monitor	Off	On
48	I/O Buffer	Off	On

All other parameters are ignored.

# 21. SET AND RESET MODE COMMANDS

## INTRODUCTION

The descriptions for the Set and Reset Mode commands are divided into Parts I, II and III. The lead-in sequence for Part I commands is Hex 1B 5B 3F, and for Part II commands is only Hex 1B 5B. Commands in Part III have a completely different structure from those in Parts I and II.

### 21.1 SET AND RESET - PART I

#### 21.1.1 RESET MODE 1

This sequence sets one or more modes as defined by each selective parameter in the parameter string; each mode to be set is specified by a separate parameter. Refer to Set Mode, below.

#### 21.1.2 SET MODE 1

This sequence sets one or more modes as defined by each selective parameter in the parameter string. Each mode to be set is specified by a separate parameter. A mode is considered to be set until it is reset by a Reset Mode sequence (see above).

#### CURSOR KEYS MODE - Ps 1

**Set:** Application Functions

**Reset:** Cursor Control

The Set and Reset Cursor Control functions are only effective when the terminal is in ANSI Mode. The Set Mode sequence will cause the four cursor function keys to send application functions. The Reset Mode sequence will cause these keys to send ANSI cursor control commands (Refer to Section 8.3.2).

## LIST OF COMMANDS

- 21.1 PART I    RESET MODE 1  
                  SET MODE 1
- 21.2 PART II    KEYPAD APPLICATION MODE  
                  KEYPAD NUMERIC MODE  
                  ENTER ANSI MODE
- 21.3 PART III    RESET MODE 2  
                  SET MODE 2

#### Function No. N/a

**ANSI:**            1B 5B 3F Ps 3B Ps 3B Ps 6C  
                  CSI    ? Ps ; Ps ; Ps I

**CUSTOM**  
**DEFAULT:**      1B 5B 3F Ps 3B Ps 3B Ps 6C  
                  CSI    ? Ps ; Ps ; Ps I

**REASSIGNED:** Not Applicable

#### Function No. N/a

**ANSI:**            1B 5B 3F Ps 3B Ps 3B Ps 68  
                  CSI    ? Ps ; Ps ; Ps h

**CUSTOM**  
**DEFAULT:**      1B 5B 3F Ps 3B Ps 3B Ps 68  
                  CSI    ? Ps ; Ps ; Ps h

**REASSIGNED:** Not Applicable

#### COMMAND MODE - Ps 2

**Set:** Not Applicable    **Reset:** Custom

The Reset Mode sequence causes only Custom or Re-assigned Mode compatible escape sequences to be interpreted and executed. The Set Mode sequence does not apply in ANSI mode. Refer to Section 21.2, Set and Reset Commands Part II.



**SCROLLING MODE - Ps 4**

**Set:** Smooth            **Reset:** Jump

The Set Mode sequence provides "smooth" scrolling at a maximum execution rate of 6 or 12 lines per second, selectable in Set-up Mode. Smooth scrolling is not available in the Portrait Display format. The Reset Mode sequence causes the scroll to "jump" from line to line instantaneously.

**SCREEN MODE - Ps 5**

**Set:** Reverse            **Reset:** Normal

The Set Mode sequence presents a light screen with dark characters. The Reset Mode presents a dark screen with light characters. See also Sections 14.1 and 14.2, Screen Background Light/Dark.

**ORIGIN MODE - Ps 6**

**Set:** Margins            **Reset:** Home

The Set Mode sequence causes the origin (Home position) to be placed at the upper left character position within the margins. Refer to Section 14.6, Set Top and Bottom Margins. Once the margins have been defined, the line and column numbers are relative to those margin settings. The cursor is not allowed to be positioned outside the margins.

The Reset Mode sequence causes the origin (home position) to be located at the top left character position on the page (column 1, line 1). If margins have been set the line and column numbers are independent of these settings. The cursor is permitted to be positioned outside the margins.

The cursor is moved to the new Home position when this Mode is Set or Reset.

Lines and columns are numbered consecutively, with the origin (Home) being line 1, column 1 (top left character position).

**AUTOWRAP MODE - Ps 7**

**Set:** Wrap                **Reset:** No Wrap

The Set Mode sequence causes any displayable characters received when the cursor is at the right margin to advance to the beginning of the next line, performing a scroll up if required and permitted; Reset Mode causes these characters to overwrite any previous characters at the right margin.

**AUTO-REPEAT MODE - Ps 8**

**Set:** Repeat            **Reset:** No Repeat

The Set Mode sequence causes certain keyboard keys to auto-repeat (see Section 8, Keyboard). The Reset Mode sequence prevents auto-repeat.

**SEND MODE REMOTE CHANGE - Ps 10**

**Set:** Block                **Reset:** Character Mode

Applicable to Set and Reset mode. When Set, the Terminal is in Block Mode. When Reset, the terminal enters the On-Line Mode and behaves as an interactive terminal. (Can be saved in Set-up C mode).

**SEND EXTENT: PAGE/LINE - Ps 11**

**Set:** Line                **Reset:** Page

Requires Send key to be set to Extent. Applicable to Set and Reset Mode. When Set, the terminal is in Line Transmit mode. When Reset, the terminal is in Page Send Extent.

**SPACE COMP./FIELD DELIMITING MODE - Ps 13**

**Set:** On                    **Reset:** Off

Applicable to Set and Reset Mode. The Reset state causes characters to be transmitted as they are encountered. The Set state causes all trailing spaces in a field to be suppressed. All fields sent are terminated by a single record separator character (RS, Hex 1E) except the last field, which is delimited by a CR (0D) or CR LF (0D, 0A) character.

The Guarded Area Transfer Mode (GATM) control sequence also affects the data sent. For an explanation of how these two control sequences interact see the compression and suppression discussion.

**TRANSMIT EXECUTION MODE/REQUEST SEND - Ps 14**

**Set:** Local                **Reset:** Remote Initiate

Applicable to Set and Reset Mode. When Set, with the terminal in Block Mode, pressing [ENTER] (or [RETURN] if Line Send is selected) initiates sending line, partial page or page data, as appropriate. When Reset, with the terminal in Edit Mode, pressing [ENTER] sends ESC S (Hex 1B 53), alerting the host that the terminal wishes to transmit data. No further transmission occurs until the terminal receives the Transmit control sequence. The default condition is Send Direct.

**SELECT MULTI PAGE MODE - Ps 31**

**Set:** 1 \* 72      **Reset:** 3 \* 24

The Reset command sets the Terminal to three 24-line pages, each page acting independent of the other two. This is the default condition. The Set command sets the terminal to one 72 line page. Either of these Mode changes moves the cursor to 'Super Home', which is page 1, line 1, column 1.

**SCROLL MODE - Ps 32**

**Set:** Page      **Reset:** Scroll

The Reset command sets the terminal to Scroll Enable, and this is the default condition. The Set command sets the terminal to the Scroll Disable Mode, also referred to as the "Page-Mode". This means that when the cursor gets to the 24th or 72nd line (depending on Multi-page, Big Page or Flip Page Mode) no scroll is performed and the cursor is moved to the first unprotected line on the same page.

**CURSOR ON/OFF - Ps 35**

**Set:** Off      **Reset:** On

In Set Mode the cursor is turned off, i.e. not displayed on the screen. Reset Mode turns the cursor on.

**SCREEN ON/OFF - Ps 36**

**Set:** Off      **Reset:** On

In Set Mode the screen is blank and no data will be displayed. In Reset Mode data will be displayed.

**STATUS LINE ON/OFF - Ps 40**

**Set:** Off      **Reset:** On

In Set Mode the Status Line will not be displayed at the bottom of the screen; in Reset Mode the preselected Status Line functions will be shown.

**STATUS LINE USER/STATUS - Ps 41**

**Set:** User Line      **Reset:** Status Line

In Set Mode the Status Line will show User information. In Reset Mode the Status line will show Status information.

**STATUS LINE CURSOR POSITION - Ps 42**

**Set:** Off      **Reset:** On

In Set Mode the cursor position will not be shown on the Status Line. In Reset Mode the current cursor position will be shown, by page, line and column, numbered according to the Origin Mode condition.

**TIME - Ps 43**

**Set:** Off      **Reset:** On

In Set Mode the current time will not be shown on the Status Line. In Reset Mode the time will be shown as HHMMSS (Hours, Minutes, Seconds).

**Reserved - Ps 44**

**PRINT STATUS - Ps 45**

**Set:** Off      **Reset:** On

In Set Mode no Print Status will be shown on the Status Line; in Reset Mode the Print Status will be given.

**TRANSMISSION MODE - Ps 46**

**Set:** Off      **Reset:** On

When Reset the current transmission mode (Interactive or selected Block Mode - see Section 7, Fig. 13) will be displayed on the Status Line. When Set the transmission mode will not be displayed.

**INTERFACE MONITOR - Ps 47**

**Set:** Off      **Reset:** On

In Set Mode the interface will not be monitored. In Reset Mode the condition of each interface line will be shown on the Status Line.

**I/O BUFFER - Ps 48**

**Set:** Off      **Reset:** On

In Set Mode the status of the I/O Buffer will not be shown on the Status Line. In Reset Mode the contents of the I/O Buffer will be indicated graphically.

## 21.2 SET AND RESET - PART II

### 21.2.1 KEYPAD APPLICATION MODE

The numeric keypad keys will transmit code sequences as defined in Section 8.3.2, Transmitted Codes.

Function No. 58

ANSI:           1B 3D  
                  ESC =

CUSTOM  
DEFAULT:       1B 3D  
                  ESC =

REASSIGNED: \_\_\_\_\_

### 21.2.2 KEYPAD NUMERIC MODE

The numeric keypad keys will send ASCII codes corresponding to the characters on the keytops.

Function No. 57

ANSI:           1B 3E  
                  ESC >

CUSTOM  
DEFAULT:       1B 3E  
                  ESC >

REASSIGNED: \_\_\_\_\_

### 21.2.3 ENTER ANSI MODE

Causes the terminal to respond and act according to the ANSI defined functions and codes.

Function No. 150

ANSI:           Not Applicable

CUSTOM  
DEFAULT:       1B 3C  
                  ESC <

REASSIGNED: \_\_\_\_\_

### 21.2.4 ENTER CUSTOM MODE

Causes the terminal to respond and act according to the Custom defined functions and codes.

Function No. N/a

ANSI:           1B 5B 3F 32 6C  
                  CSI    ?  2  I

CUSTOM  
DEFAULT:       Not Applicable

REASSIGNED: Not Applicable

**21.3 SET AND RESET - PART III**

**21.3.1 RESET MODE 2**

This sequence resets one or more modes as defined by each selective parameter in the parameter string; each mode to be reset is specified by a separate parameter. Refer to Set Mode, see below.

**21.3.2 SET MODE 2**

This sequence sets one or more modes as defined by each selective parameter in the parameter string; each mode to be set is specified by a separate parameter. A mode is considered set until it is reset by a Reset Mode sequence. Refer to Reset Mode, see above.

**SUMMARY OF SET AND RESET PART III PARAMETERS**

PARAMETER (Ps)	MODE FUNCTION
1	Send Data Type
4	Insertion Mode
6	Erasur Mode
16	Send Full Extent
18	Print Termination
19	Print Extent
20	Linefeed/New Line
21	Print Pages
22	Print Expanded Mode
23	Display Mode Change Response

**SEND DATA TYPE - Ps 1**

**Set:** All                      **Reset:** Partial

Applicable to Set and Reset Mode. When Reset only unprotected data is transmitted. If a protected field is encountered, a Record Separator (Hex 1E) is transmitted. When Set, all data is transmitted regardless of protection.

**Function No. \_\_\_\_\_ N/a**

**ANSI:**                      1B 5B Ps 3B Ps 3B Ps 6C  
CSI Ps ; Ps ; Ps l

**CUSTOM**  
**DEFAULT:**                1B 5B Ps 3B Ps 3B Ps 6C  
CSI Ps ; Ps ; Ps l

**REASSIGNED:** \_\_\_\_\_

**Function No. \_\_\_\_\_ N/a**

**ANSI:**                      1B 5B Ps 3B Ps 3B Ps 68  
CSI Ps ; Ps ; Ps h

**CUSTOM**  
**DEFAULT:**                1B 5B Ps 3B Ps 3B Ps 68  
CSI Ps ; Ps ; Ps h

**REASSIGNED:** \_\_\_\_\_

SET	RESET
All	Partial
On	Off
All	Unprotected
Full	To Cursor
FF	None
All	Region
New Line	Linefeed
All	Active Page
On	Off
Requested	Automatic

**INSERTION/REPLACEMENT MODE - Ps 4**

**Set:** On                      **Reset:** Off

In the Insertion Mode each new insert character received is displayed at the cursor position and all characters from the cursor position to the right margin are shifted one place to the right; the rightmost character is lost. Insertion Mode can be indicated on the Status Line.

In the Replacement Mode each character received is displayed at the cursor position overwriting (replacing) the character which was previously displayed. The terminal normally enters Replacement Mode on power-up.

**ERASURE MODE - Ps 6**

**Set:** All                    **Reset:** Unprotected

When Reset, the erase commands (Erase in Display, Erase in Line and Home and Clear) do not erase protected data. When Set, those commands erase any data regardless of protection.

**SEND FULL EXTENT/TO CURSOR - Ps 16**

**Set:** Full                    **Reset:** Send to Cursor.

When Set, the full page, scrolling region or line is transmitted, as appropriate. When Reset, only the data up to the current cursor position is sent.

**PRINT TERMINATION CHARACTER MODE - Ps 18**

**Set:** Formfeed            **Reset:** None

When Set the Terminal will add a Formfeed character (Hex 0C) at the end of the data sent to the printer after each printed page - by the Print Page or Print Screen command. The default state is set by a switch in Set-up Mode.

When Reset no more characters will be added to the Print Page data.

**PRINT EXTENT - Ps 19**

**Set:** All                    **Reset:** Region

When Set the Print Page command will print the contents of the entire screen. The default state is set by a switch in Set-up C mode.

When Reset the Print Page command will print only the contents of the scrolling region.

**LINE FEED/NEW LINE MODE - Ps 20**

**Set:** New Line            **Reset:** Line Feed

The Reset Mode sequence causes the cursor to move vertically when an LF code is received, and the [RETURN] key to send the single code Hex 0D when depressed. The Set Mode sequence causes the cursor to move to the first position of the following line, when LF is received, and causes the [RETURN] key to send the two codes Hex 0D, 0A. The state of this option upon power up is determined by a switch setting in Custom Mode Set-up 4, Switch CM: 1.2.

**PRINT PAGES - ALL/ACTIVE PAGE - Ps 21**

**Set:** All                    **Reset:** Active Page

In Set Mode all three Flip Pages or the Big Page are transferred to the connected printer.

In Reset Mode the page holding the active cursor position is transferred to the connected printer.

**PRINT EXPANDED MODE - Ps 22**

**Set:** On                    **Reset:** Off

The Reset command sets the terminal to Print Expanded Mode off, and this is the default condition. All characters normally stored as control characters (semi-graphic set) on the screen are sent out as an asterisk (Hex 2A). The Set command enables the Print Expanded Mode video attributes and character set information to be passed on to the printer.

**DISPLAY MODE CHANGE RESPONSE - Ps 23**

**Set:** Requested            **Reset:** Automatic

The Reset Mode (default mode) causes the terminal to automatically transmit the "REPORT DISPLAY MODE" response when the screen is changed from Landscape to Portrait and vice versa.

The Set mode disables the "REPORT DISPLAY MODE" response unless requested by the "REPORT DISPLAY MODE" command.

# 22. REPORT COMMANDS

## INTRODUCTION

Terminal and printer status reports are sent to the host by means of these commands.

## LIST OF COMMANDS

- 22.1 CURSOR POSITION REPORT
- 22.2 REPORT DISPLAY MODE
- 22.3 DEVICE STATUS REPORT
- 22.4 DEVICE ATTRIBUTES
- 22.5 PRINTER STATUS REPORT
- 22.6 LOAD RESPONSE

### 22.1 CURSOR POSITION REPORT

This sequence requests the cursor position of the terminal. In **ANSI Mode** it is sent to the host by means of two numeric parameters, PnI specifying the line and Pnc specifying the column, thus:

Hex 1B 5B PnI 3B Pnc 52

The numbering of lines depends on the state of the Origin Mode.

In **Custom Mode** the cursor position co-ordinates are sent to the host in ASCII followed by a Carriage Return (CR).

### 22.2 REPORT DISPLAY MODE

This sequence requests the terminal to transmit information on the current Display Mode. The same response can be set so that it is transmitted automatically, refer to the Display Mode Change Response function.

#### Response Codes:

	LANDSCAPE	PORTRAIT
ANSI:	1B 5B 3F 4C 6E	1B 5B 3F 50 6E
	CSI ? L n	CSI ? P n
CUSTOM		
DEFAULT:	1B 5B 3F 4C 6E	1B 5B 3F 50 6E
	CSI ? L n	CSI ? P n

USER LOADED  
RESPONSE: \_\_\_\_\_

### Function No. 152

ANSI: 1B 5B 36 6E  
CSI 6 n

CUSTOM  
DEFAULT: 1B 45  
ESC E

REASSIGNED: \_\_\_\_\_

### Function No. 157

ANSI: 1B 5B 3F 31 6E  
CSI ? 1 n

CUSTOM 1B 5B 3F 31 6E  
DEFAULT: CSI ? 1 n

REASSIGNED: \_\_\_\_\_

**22.3 DEVICE STATUS REPORT**

The general status of the terminal is reported in the following format: **1B 5B Ps 6E**

PARAMETER (Ps)	PARAMETER MEANING
0	Ready. No malfunctions detected.
3	Malfunction - retry.

**22.4 DEVICE ATTRIBUTES**

The host requests the terminal to return a DA control sequence identifying itself with either no parameter or a parameter value of 0.

The response to the request described above (terminal to host) is generated by the terminal as a DA control sequence with numerical parameters as shown here:

**Response Codes:**

OPTION PRESENT	SEQUENCE SENT
No options (AVO)	<b>1B 5B 3F 31 3B 32 63</b> CSI ? 1 ; 2 c

**USER LOADED RESPONSE:** \_\_\_\_\_

**22.5 PRINTER STATUS REPORT**

The host may request a report from the terminal regarding the status of the printer by using this command. This avoids the possibility of the terminal sending X-OFF (BUSY) if the printer is unavailable when the host starts sending data to the printer. The response sent by the terminal to the host will be one of the following:

Response: Printer Ready

ANSI: **1B 5B 3F 31 30 6E**

Response: Printer Busy

ANSI: **1B 5B 3F 31 31 6E**

Response: No Printer Connected

ANSI: **1B 5B 3F 31 33 6E**

**Note:** If the printer is to be used, before using the terminal, then ensure that the printer is connected, powered up and is on-line.

**Function No. 158**

ANSI: **1B 5B 35 6E**  
CSI 5 n

**CUSTOM DEFAULT:** **1B 5B 35 6E**  
CSI 5 n

REASSIGNED: \_\_\_\_\_

**Function No. 159**

ANSI: **1B 5B Pn 63**  
CSI Pn c

or **1B 5A**  
ESC Z

**CUSTOM DEFAULT:** **1B 5A**  
ESC Z

REASSIGNED: \_\_\_\_\_

**Function No. 160**

ANSI: **1B 5B 3F 31 35 6E**  
CSI ? 1 5 n

**CUSTOM DEFAULT:** **1B 5B 3F 31 35 6E**  
CSI ? 1 5 n

REASSIGNED: \_\_\_\_\_

**22.6 LOAD RESPONSE**

PARAMETER (Ps)	PARAMETER MEANING
0	Landscape response
1	Portrait response
3	Device attribute response

A maximum of 10 characters may be included in the string. The string is terminated with Hex 7F, which is not included in the response.

In Custom Mode the function is defined as a control character or escape sequence. To load the user response transmit the following sequence.

**<Command> Ps STRING DEL**

**Function No. 162**

**ANSI:** 1B 5B 3F Ps 4D STRING 7F  
CSI ? Ps M STRING DEL

**CUSTOM**

**DEFAULT:** 1B 5B 3F Ps 4D STRING 7F  
CSI ? Ps M STRING DEL

**REASSIGNED:** \_\_\_\_\_





## 23. RESET AND TEST COMMANDS

### INTRODUCTION

These three commands are concerned with testing the terminal and are intended for use by servicing personnel.

### LIST OF COMMANDS

- 23.1 RESET TO INITIAL STATE
- 23.2 SCREEN ALIGNMENT DISPLAY
- 23.3 INVOKE TESTS
- 23.4 REQUEST TERMINAL PARAMETERS

#### 23.1 RESET TERMINAL

This sequence resets the Terminal to its initial state, i.e. the state it was in immediately after switching on. This sequence also causes the power-up self test to be executed.

Function No. 163

ANSI:           1B 63  
                  ESC c

CUSTOM  
DEFAULT:       1B 30  
                  ESC 0

REASSIGNED: \_\_\_\_\_

#### 23.2 SCREEN ALIGNMENT DISPLAY

This is a command used by servicing personnel to fill the entire screen area with uppercase E's for screen focus and alignment.

Function No. N/a

ANSI:           1B 23 38  
                  ESC # 8

CUSTOM  
DEFAULT:       1B 23 38  
                  ESC # 8

REASSIGNED: Not Applicable

#### 23.3 INVOKE TESTS

This command initiates a series of special tests for use by servicing personnel.

Function No. N/a

ANSI:           1B 5B 32 3B Ps 79  
                  CSI 2 ; Ps y

CUSTOM  
DEFAULT:       1B 5B 32 3B 39 79  
                  CSI 2 ; 9 y

REASSIGNED: Not Applicable

PARAMETER (Ps)	PARAMETER MEANING
1	The tests are performed once
9	The tests are repeated until a failure occurs or until power is switched off.

**23.4 REQUEST TERMINAL PARAMETERS**

This sequence requests the selected terminal parameters.

**Response Codes:****ANSI:**

1B 5B <Ps> 3B <Par I/O> 3B <nbits I/O>  
CSI <Ps> ; <Par I/O> ; <nbits I/O>

3B <xspeed I/O> 3B <rspeed I/O> 3B 31 3B  
; <xspeed I/O> ; <rspeed I/O> ; 1 ;

30 3B <Mode> 3B <Par Pr> 3B <nbits Pr>  
0 , <Mode> ; <Par Pr> ; <nbits Pr>

3B <xspeed Pr> 3B <rspeed Pr> 78  
, <xspeed Pr> ; <rspeed Pr> x

Parameter	Value	Meaning
<Ps>	3	This message is a report and the terminal is only reporting on request.
<Par I/O>	1	No parity set
	4	Parity set - odd
	5	Parity set - even
<nbits I/O>	1	8 bits per character
	2	7 bits per character
	8	75
	16	110
	24	134.5
	32	150
	40	200
	48	300
<xspeed I/O>	56	600 Bits per sec
<rspeed I/O>	64	1200
	80	2000
	88	2400
	104	4800
	112	9600
	120	19200

**CUSTOM**

DEFAULT: As for ANSI

**Function No.****N/a**

ANSI: 1B 5B 31 78  
CSI 1 x

**CUSTOM**

DEFAULT: 1B 5B 31 78  
CSI 1 x

REASSIGNED: Not Applicable

Parameter	Value	Meaning
<Mode>	0	Custom
	1	ANSI
<Par Pr>	1	No parity set
	4	Parity set - odd
	5	Parity set - even
<nbits>	1	8 bits per character
	2	7 bits per character
<xspeed pr>		As for <xspeed I/O>
<rspeed pr>		and <rspeed I/O>

# 24. PRINT COMMANDS

## INTRODUCTION

These commands are used to control the interaction between the terminal and the printer.

When exiting the Printer Controller or Expanded Print Modes, the printer stay in the last used state. Therefore it is recommended to Reset the Printer after operation of these modes.

## LIST OF COMMANDS

- 24.1 PRINT LINE
- 24.2 PRINT PAGE
- 24.3 ENTER AUTO-PRINT MODE
- 24.4 EXIT AUTO-PRINT MODE
- 24.5 ENTER PRINTER CONTROLLER MODE
- 24.6 EXIT PRINTER CONTROLLER MODE
- 24.7 ENTER EXP PRINT MODE
- 24.8 EXIT EXP PRINT MODE
- 24.9 PRINT TERMINATION CHAR - FF
- 24.10 PRINT TERMINATION CHAR - NONE
- 24.11 PRINT EXTENT - SCREEN
- 24.12 PRINT EXTENT - PAGE
- 24.13 PRINT ACTIVE PAGE
- 24.14 PRINT ALL PAGES

### 24.1 PRINT LINE

When this command is received the line containing the cursor is sent to the printer. The terminal must not be in either of the printing modes when this command is given.

### Function No. 166

ANSI: 1B 5B 3F 31 69  
CSI ? 1 i

CUSTOM  
DEFAULT: 1B 56  
ESC V

REASSIGNED: \_\_\_\_\_

### 24.2 PRINT PAGE

The contents of the current active page are sent to the printer on receipt of this command. The current page may be all pages, the entire active page or just the scrolling region depending on the selection of Print Extent. The terminal might terminate page printing with a Form Feed (see the Print Termination Character Mode command). The terminal must not be in either of the printing modes when this command is given.

### Function No. 167

ANSI: 1B 5B 69  
CSI i

CUSTOM  
DEFAULT: 1B 5D  
ESC J

REASSIGNED: \_\_\_\_\_

**24.3 ENTER AUTO-PRINT MODE**

When the terminal enters the Auto-print Mode on receipt of this command, it sends the contents of the cursor line to the printer whenever a Line Feed is performed. This Mode may also be entered by the operator pressing [CONTROL] + [ENTER].

**Function No. 168**

ANSI: 1B 5B 3F 35 69  
CSI ? 5 i

CUSTOM  
DEFAULT: 1B 5E  
ESC ^

REASSIGNED: \_\_\_\_\_

**24.4 EXIT AUTO-PRINT MODE**

This command terminates the Auto-print Mode, which may also be terminated by the operator pressing [CONTROL] + [ENTER].

**Function No. 169**

ANSI: 1B 5B 3F 34 69  
CSI ? 4 i

CUSTOM  
DEFAULT: 1B 5F  
ESC -

REASSIGNED: \_\_\_\_\_

**24.5 ENTER PRINTER CONTROLLER MODE**

After this command the terminal will send all received characters to the printer without displaying them, unless no printer is connected, when the characters will be displayed instead of printed. None of the data is interpreted as a terminal command except the Exit Printer Controller Mode command.

**Function No. 170**

ANSI: 1B 5B 35 69  
CSI 5 i

CUSTOM  
DEFAULT: 1B 67  
ESC g

REASSIGNED: \_\_\_\_\_

**24.6 EXIT PRINTER CONTROLLER MODE**

This command is detected by the terminal when in the Printer Controller Mode and causes the terminal to display all subsequent data instead of printing it. No characters of this command are passed to the printer.

**Function No. 171**

ANSI: 1B 5B 34 69  
CSI 4 i

CUSTOM  
DEFAULT: 1B 68  
ESC h

REASSIGNED: \_\_\_\_\_

**24.7 ENTER EXPANDED PRINT MODE**

When the terminal enters the Expanded Print Mode on receipt of this command, the video attributes and character set information are passed on to the printer.

**Function No. 172**

ANSI: 1B 5B 32 32 68  
CSI 2 2 h

CUSTOM  
DEFAULT: 1B 5B 32 32 68  
CSI 2 2 h

REASSIGNED: \_\_\_\_\_

**24.8 EXIT EXPANDED PRINT MODE**

When the terminal exits the Expanded Print Mode on receipt of this command, all the characters which are normally stored as control characters (Semi-graphic set) on the screen are sent out as asterisks (Hex 2A).

**Function No. 173**

ANSI: 1B 5B 32 32 6C  
CSI 2 2 I

CUSTOM  
DEFAULT: 1B 5B 32 32 6C  
CSI 2 2 I

REASSIGNED: \_\_\_\_\_

**24.9 PRINT TERMINATION CHAR. - FF**

When this command is enabled the terminal will add a Form Feed character (Hex 0C) to the end of the data sent to the printer after a Print Page command. The default state is set by a switch in Set-up C Mode.

**Function No. 174**

ANSI: 1B 5B 31 38 68  
CSI 1 8 h

CUSTOM  
DEFAULT: 1B 5B 31 38 68  
CSI 1 8 h

REASSIGNED: \_\_\_\_\_

**24.10 PRINT TERMINATION CHAR. - NONE**

On receipt of this command the terminal will not add any character to the end of the data sent to the printer after a Print Page command.

**Function No. 175**

ANSI: 1B 5B 31 38 6C  
CSI 1 8 I

CUSTOM  
DEFAULT: 1B 5B 31 38 6C  
CSI 1 8 I

REASSIGNED: \_\_\_\_\_

**24.11 PRINT EXTENT - SCREEN**

When this function has been enabled, any subsequent Print Page command will print the entire screen contents. The default state is set by a switch in Set-up C Mode.

**Function No. 176**

ANSI: 1B 5B 31 39 68  
CSI 1 9 h

CUSTOM  
DEFAULT: 1B 5B 31 39 68  
CSI 1 9 h

REASSIGNED: \_\_\_\_\_

**24.12 PRINT EXTENT - REGION**

When this function has been enabled, any subsequent Print Page command will print the contents of the scrolling region.

**Function No. 177**

ANSI: 1B 5B 31 39 6C  
CSI 1 9 I

CUSTOM  
DEFAULT: 1B 5B 31 39 6C  
CSI 1 9 I

REASSIGNED: \_\_\_\_\_

**24.13 PRINT ACTIVE PAGE**

This function causes the contents of the active page on the screen to be printed out when a Print Page command is issued, subject to the Print Extent requirement (Functions 176 and 177).

**Function No.****178**

**ANSI:**           1B 5B 32 31 6C  
                  CSI     2 1 1

**CUSTOM**

**DEFAULT:**     1B 5B 32 31 6C  
                  CSI     2 1 1

**REASSIGNED:** \_\_\_\_\_

**24.14 PRINT ALL PAGES**

This function causes all pages to be printed out when a Print Page command is issued, subject to the Print Extent requirement (Functions 176 and 177).

**Function No.****179**

**ANSI:**           1B 5B 32 31 68  
                  CSI     2 1 h

**CUSTOM**

**DEFAULT:**     1B 5B 32 31 68  
                  CSI     2 1 h

**REASSIGNED:** \_\_\_\_\_

## 25. DOWNLINE LOADING

### INTRODUCTION

These commands are concerned with downline loading of the user definable function keys, command codes and report available EAROM.

### LIST OF COMMANDS

- 25.1 USER DEFINABLE FUNCTION KEYS
- 25.2 COMMAND CODES
- 25.3 REPORT AVAILABLE EAROM

#### 25.1 USER DEFINABLE FUNCTION KEYS

This function enables the host to define the twelve programmable function keys (F1 to F12).

The function keys to be defined are selected according to the following parameters:

PARAMETER (Pn)	PARAMETER MEANING
Pn 1 to Pn 12	Unshifted F1 to F12
Pn 13 to Pn 24	Shifted F1 to F12

The delimiter can be any character not included in the code string (CS). The code string is the function to be downloaded, of a maximum 63 characters.

Note: If Pn = 0, CS = CLEAR (Hex 43 4C 45 41 52) and there are no delimiters, then both unshifted and shifted F1 to F12 keys are cleared.

Example: Define the shifted key F12 to give the message "HELLO" followed by CR, using "=" as the delimiter.

```
1B 7F 35 31 20 32 34 3A 3D 48 45 4C
ESC DEL 5 1 SP 2 4 : = H E L
```

```
4C 4F 0D 3D
L O CR =
```

#### Function No. N/a

**ANSI:**           1B 7F 35 31 20 Pn 3A delimiter  
                  ESC DEL 5 1 SP Pn : delimiter

CS delimiter  
CS delimiter

**CUSTOM**  
**DEFAULT:**   1B 7F 35 31 20 Pn 3A delimiter  
                  ESC DEL 5 1 SP Pn : delimiter

CS delimiter  
CS delimiter

**REASSIGNED:** Not applicable



**25.2 COMMAND CODES**

This function downloads control and command sequences.

Parameter Fnr indicates the function number: Fnr 1 to 207. CODE is one byte, Hex 00 to 1F for control codes and Hex 20 to 7E for the character following the lead-in code.

Note: If Fnr = 0, CODE = CLEAR (Hex 43 4C 45 41 52) and there are no delimiters, then all functions are cleared.

**25.3 REPORT EAROM**

The host may request a report from the terminal regarding the total number of available EAROM bytes.

Response:

**1B 5B 3F N 75**

N = Number of available EAROM bytes expressed in ASCII, e.g. 120 bytes N will be Hex 31 32 30.

**Function No. N/a**

**ANSI:** 1B 7F 36 31 20 Fnr 3A delimiter  
ESC DEL 6 1 SP Fnr : delimiter

CODE delimiter

CODE delimiter

**CUSTOM**

**DEFAULT:** 1B 7F 36 31 20 Fnr 3A delimiter  
ESC DEL 6 1 SP Fnr : delimiter

CODE delimiter

CODE delimiter

**REASSIGNED: Not applicable**

**Function No. N/a**

**ANSI:** 1B 5B 3F 75  
CSI ? u

**CUSTOM**

**DEFAULT:** 1B 5B 3F 75  
CSI ? u

**REASSIGNED: Not applicable**

## 26. INTERFACE INFORMATION

The two female interface connectors at the rear of the terminal are shown in Fig. 33.

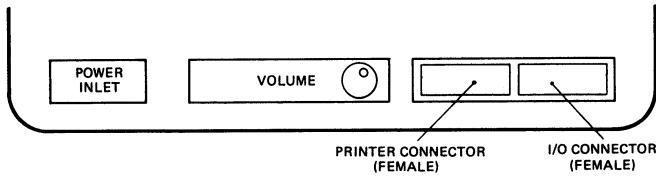
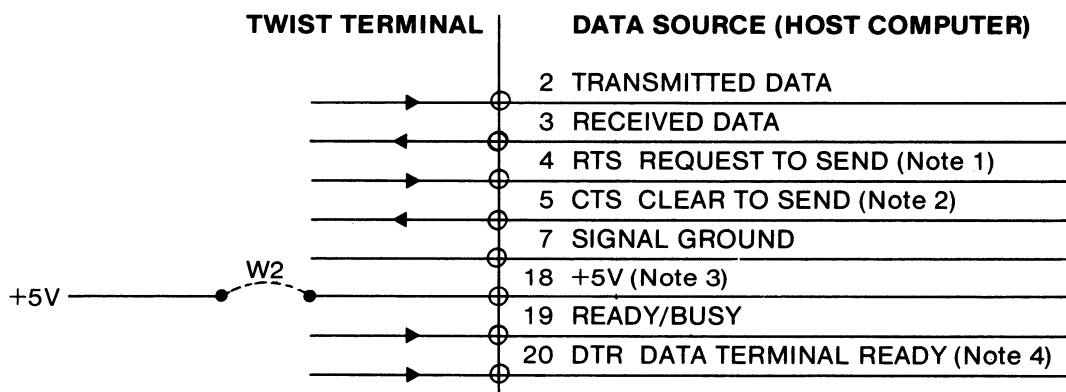

**Fig.33** Location of Interface Connectors

### 26.1 V.24/RS-232-C COMMUNICATION INTERFACE

Pin assignments for the 25-pin female V.24/RS-232-C communication connector are shown in Fig. 34 below:

The selection of communication data rate is described in Section 9.5.2; the data word characteristics and Half/Full Duplex selection are described in Section 9.5.1.



**Notes:**

1. Refer to Half/Full Duplex, section 4.1.3.
2. Assumed to be high when not connected.
3. +5V available if jumper W2 inserted.
4. High when power is on.

**Fig.34** I/O Connector Pin Allocations

**26.2 V.24/RS-232-C PRINTER INTERFACE**

The pin assignments for the female V.24/RS-232-C printer connector are as shown in Fig. 35 below:

**26.3 I/O CURRENT LOOP INTERFACE**

A current loop interface adapter may be fitted on to the I/O interface connector. The terminal's I/O port connectors may be internally linked (via Jumper W2) to provide a +5V supply to the adapter, which is all that is required for passive/passive operation. Where the user wishes to employ an active transmitter an external 12V supply must be provided.

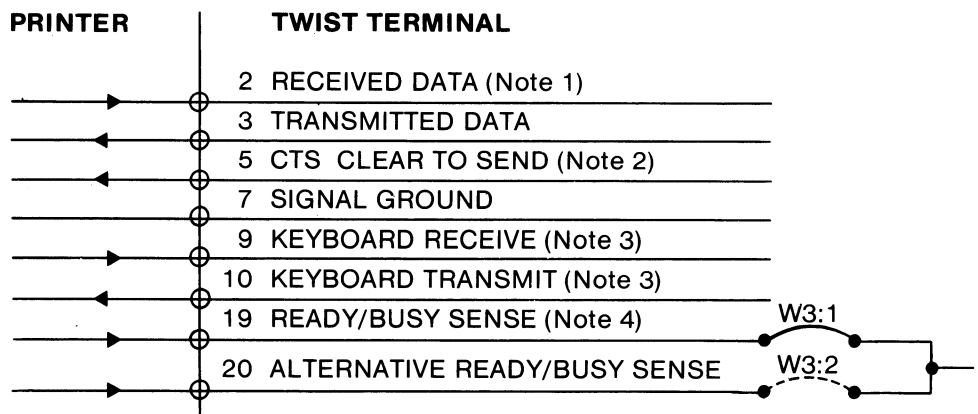

**Notes:**

1. X-ON/X-OFF from Printer.
2. High signal to Printer.
3. For servicing purposes only.
4. High is interpreted as Printer Ready. Low is interpreted as Printer Busy.

**Fig.35 Printer Connector Pin Allocations**

The selection of printer data rate is described in Section 9.6.2 and the printer data word characteristics are set as described in Section 9.6.1.

## 27. INSTALLATION

### 27.1 INITIAL SETTING UP

The terminal display unit should be positioned on a firm surface; the screen can be tilted to allow the user to optimise the viewing angle. The keyboard angle may also be selected to provide the most comfortable position by folding the small flap underneath out or in. The keyboard connector (at the end of the coiled connector lead) plugs into a socket at the right side of the display unit. The keyboard may then be positioned to best suit the user.

Ensure that the mains supply lead is terminated in a suitable plug for the local power outlet (a ground connection must be incorporated).

Refer to Section 26 for interface connections to both the host computer and a local printer (if required) and to Sections 9 and 10 for details of user-selectable options.

### 27.2 ACCESS TO MAIN LOGIC BOARD IN DISPLAY UNIT

The user may need access to the main logic board in the Display Unit to alter the settings of the interface connections described in Section 26. The Jumper locations are described in Section 29. Access is gained as follows.

1. Switch off the unit and disconnect the mains supply. Ensure that there is a stable flat surface behind the unit, large enough to rest the back panel on, when it is folded down.
2. Remove the **outer** six screws from the rear of the Display unit.
3. Fold the Display unit rear panel back slightly and then lift it to pull out the tabs from their slots in the bottom edge.
4. Carefully lay the rear panel down, without disturbing the wiring more than necessary.
5. To refit the rear panel, first raise it and engage the three tabs at the bottom edge in their slots at the back of the main casing.
6. Close the rear panel and secure it with the six securing screws.

### 27.3 ACCESS TO KEYBOARD CIRCUIT BOARD

The user may need access to the keyboard printed circuit board to set the National Version Jumpers described in Section 29. Open the unit as follows:

1. Switch off the unit and disconnect the Keyboard from the Display Unit.
2. Turn the Keyboard over and remove the six screws from the outer edge.
3. Separate the two halves of the Keyboard to obtain access to the circuit board.
4. To reassemble the Keyboard, put the two halves together and refit the six securing screws.

### 27.4 KEYCLICK/BELL VOLUME ADJUSTMENT

The audible tones produced by the unit are generated by a small loudspeaker mounted in the main cabinet. The level of sound produced may be adjusted by using a small screwdriver to turn the SPEAKER VOLUME ADJUST potentiometer, which is located as shown on Fig. 33.

### 27.5 BRIEF OPERATING INSTRUCTIONS

1. Switch on the terminal. The mains switch is located on the front of the terminal unit, at the bottom right, and shows 'O' when the terminal is switched off.
2. If any parameter changes are to be made, first press the [SET-UP] key to obtain the Set-up A display.
3. If required, press 4 to switch the terminal to On-line, Block or Off-line. The present state is shown by the LED labelled 'On-line', which will be lit if the terminal is On-line or in Block Mode.
4. Adjust the display brightness with the [CURSOR UP] and [CURSOR DOWN] keys.
5. To enter Set-up B or C Modes, press the 5 key once or twice respectively.
6. To exit any Set-up Mode press [SET-UP] again.

#### Servicing Personnel Only

1. If required, whilst in the Set-up A Mode, press [CONTROL] + [SET-UP] to enter Custom Mode.
2. Once the Custom Mode has been entered, and Custom Mode Set-up 1 is displayed, the Custom Mode Set-up 2, 3 and 4 displays can be obtained by repeated depressions of the 5 key.



## 28. TECHNICAL SPECIFICATION

### MONITOR

Screen Capacity	3 pages of 24 lines by 80 characters or 1 page of 72 lines by 80 characters, plus 1 Status Line of 80 characters.
Characters per line	80.
Number of Lines	3 x 24 or 1 x 72.
Screen	40 MHz high resolution video monitor, black-on-white or amber.
Tube size	15" diagonal.
Viewing area	Approx. 8" x 11".
Character size	5 x 3mm (Landscape), 2.5 x 2mm (Portrait).
Refresh rate	65 Hz.
Scan method	Raster scan.
Char. generator	96 alphanumeric, 32 special graphic.
Extended (optional) char. generator	Standard plus 96 alpha-numeric, 32 special graphic.

### Interfaces

V.24/RS-232-C (I/O).

V.24/RS-232-C (Printer).

20 mA current loop (printer option).

### Protocols

Ready/Busy, X-ON/X-OFF or no protocol.

### Environmental Conditions

Temperature +10 to +40 degrees Celsius.

Relative Humidity 20 to 85% (non-conditioned)

**Power Requirements**

Voltages	98 to 132 Volts or 195 to 264 volts.
Frequencies	47 to 63Hz.
Consumption	70 Watts.

**Dimensions**Display Unit

Width	Front 350mm, Rear 390mm.
Depth	350mm.
Height	440mm.

Keyboard

Width	510mm.
Depth	195mm.
Height, Rear	Selectable 34mm or 44mm.
Height, Front	16mm.
Total weight	18.5 kg.

**Data Format**

Word length	For 8 data bits with or without parity (odd or even).
Data transfer rate	13 speeds, 75 to 19200 bps, split speed and independent for I/O and Printer Ports.

**Operator Controls and Functions**

Soft Switches	More than 70.
By software commands	More than 200.

## 29. JUMPERS

### 29.1 MAIN LOGIC BOARD

The main logic board has seven plug-in jumpers, which are used as links to alter certain interface functions on the board as detailed in the table below. In some cases, e.g. W5, the jumper socket has three pins. The connections made possible by this arrangement are referred to as W5:1 or W5:2, as shown in Fig. 36.

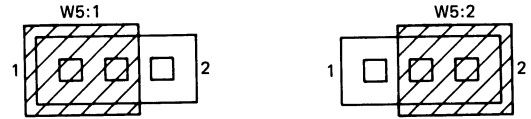

Fig.36 3-pin Jumper Notation

**Functions.**

- W1 Factory use only.
- W2 +5V to I/O Connector pin 18.
- W3 Ready/Busy to Printer Connector pin 19 or 20.
- W4 For Systems and Service use only (see Table).
- W5 Future use (select 8k RAM).
- W6 Future use (select 8k RAM).
- W7 For Systems and Service use only (see Table).

**Table of W4 and W7 Jumper Settings for Installation or Test Purposes**

W4	W7	
1	1	Normal
0	1	Factory Test Mode
0	0	Test Request Mode
1	0	Save Inhibit

### 29.2 KEYBOARD CIRCUIT BOARD

The jumpers on the Keyboard circuit board are actually wire links, which are cut according to the National version requirements as follows (0 = cut).

JUMPER					FUNCTION
W2	W3	W4	W5	W6	
1	1	1	1	1	Swedish
1	1	1	1	0	Norwegian
1	1	1	0	1	Danish
1	1	1	0	0	German
1	1	0	1	1	French
1	1	0	1	0	UK ASCII
1	1	0	0	1	Spanish
1	1	0	0	0	US ASCII



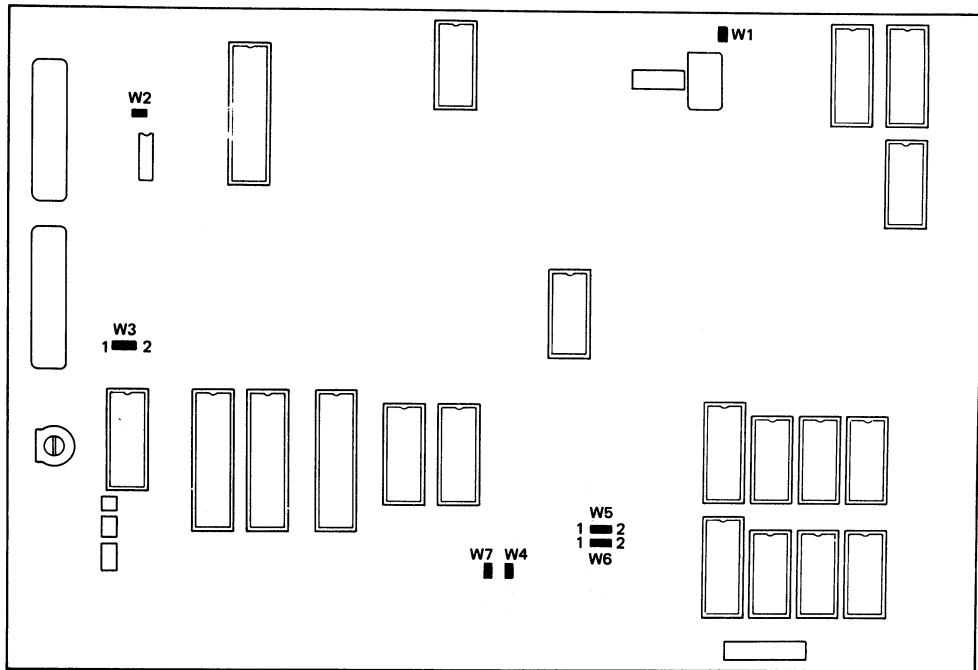

Fig.37 Location of Jumpers on Main Logic Board

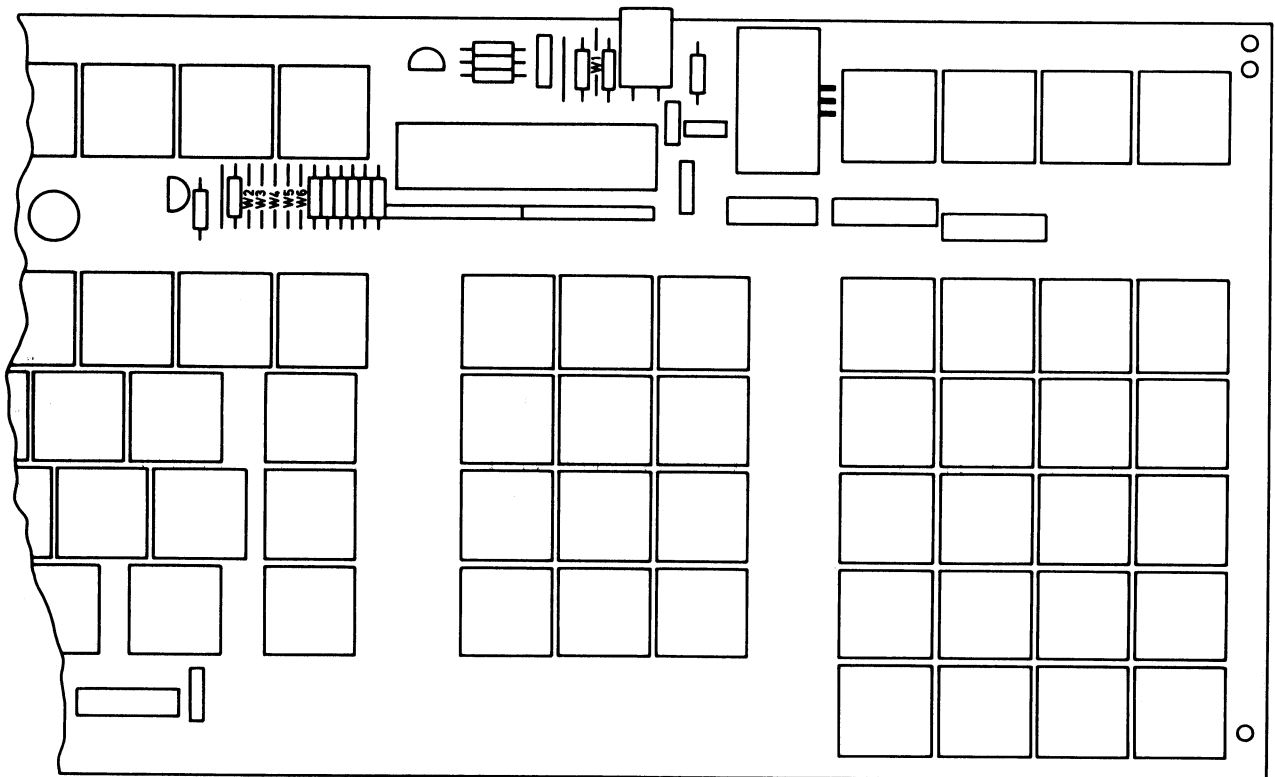
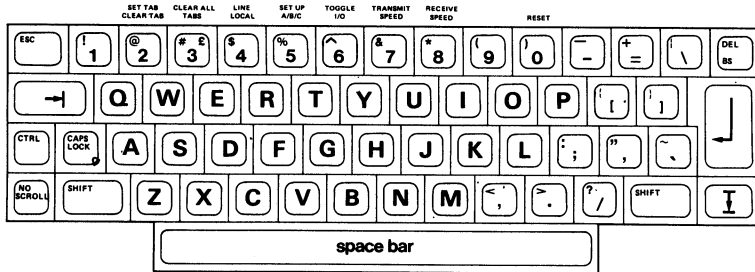

Fig.38 Location of Jumpers on Keyboard Circuit Board

# APPENDIX 1 NATIONAL KEYBOARDS AND CODE TABLES

## US ASCII



Hex	0	1	2	3	4	5	6	7
0	NUL	DLE	SP	0	@	P	.	p
1	SOH	DC1	!	1	A	Q	a	q
2	STX	DC2	"	2	B	R	b	r
3	ETX	DC3	#	3	C	S	c	s
4	EOT	DC4	\$	4	D	T	d	t
5	ENQ	NAK	%	5	E	U	e	u
6	ACK	SYN	&	6	F	V	f	v
7	BEL	ETB	'	7	G	W	g	w
8	BS	CAN	(	8	H	X	h	x
9	HT	EM	)	9	I	Y	i	y
A	LF	SUB	*	:	J	Z	j	z
B	VT	ESC	+	;	K	[	k	{
C	FF	FS	,	<	L	\	l	
D	CR	GS	-	=	M	]	m	}
E	SO	RS	.	>	N	^	n	~
F	SI	US	/	?	O	_	o	DEL

## SWEDISH

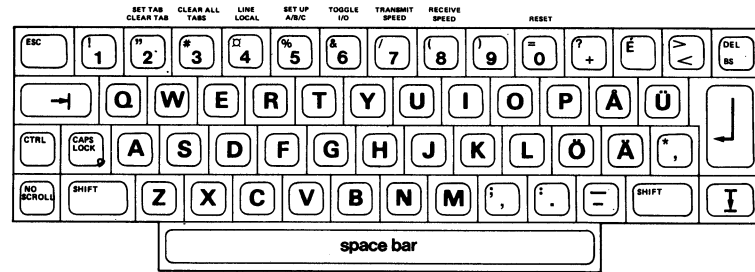

Hex	0	1	2	3	4	5	6	7
0	NUL	DLE	SP	0	É	P	é	p
1	SOH	DC1	!	1	A	Q	a	q
2	STX	DC2	"	2	B	R	b	r
3	ETX	DC3	#	3	C	S	c	s
4	EOT	DC4	¤	4	D	T	d	t
5	ENQ	NAK	%	5	E	U	e	u
6	ACK	SYN	&	6	F	V	f	v
7	BEL	ETB	'	7	G	W	g	w
8	BS	CAN	(	8	H	X	h	x
9	HT	EM	)	9	I	Y	i	y
A	LF	SUB	*	:	J	Z	j	z
B	VT	ESC	+	;	K	Å	k	ä
C	FF	FS	,	<	L	Ö	l	ö
D	CR	GS	-	=	M	Ä	m	ä
E	SO	RS	.	>	N	Ü	n	ü
F	SI	US	/	?	O	_	o	DEL

## GERMAN

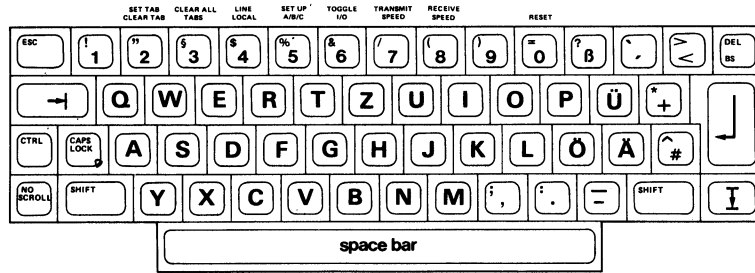

Hex	0	1	2	3	4	5	6	7
0	NUL	DLE	SP	0	§	P	.	p
1	SOH	DC1	!	1	A	Q	a	q
2	STX	DC2	"	2	B	R	b	r
3	ETX	DC3	#	3	C	S	c	s
4	EOT	DC4	\$	4	D	T	d	t
5	ENQ	NAK	%	5	E	U	e	u
6	ACK	SYN	&	6	F	V	f	v
7	BEL	ETB	'	7	G	W	g	w
8	BS	CAN	(	8	H	X	h	x
9	HT	EM	)	9	I	Y	i	y
A	LF	SUB	*	:	J	Z	j	z
B	VT	ESC	+	;	K	Ä	k	ä
C	FF	FS	,	<	L	Ö	l	ö
D	CR	GS	-	=	M	Ü	m	ü
E	SO	RS	.	>	N	~	n	ß
F	SI	US	/	?	O	_	o	DEL

## DANISH

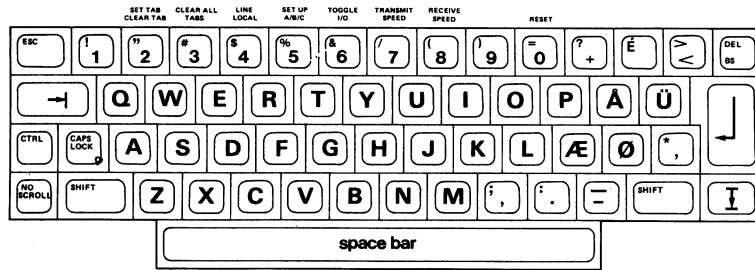

Hex	0	1	2	3	4	5	6	7
0	NUL	DLE	SP	0	É	P	é	p
1	SOH	DC1	!	1	A	Q	a	q
2	STX	DC2	"	2	B	R	b	r
3	ETX	DC3	#	3	C	S	c	s
4	EOT	DC4	\$	4	D	T	d	t
5	ENQ	NAK	%	5	E	U	e	u
6	ACK	SYN	&	6	F	V	f	v
7	BEL	ETB	'	7	G	W	g	w
8	BS	CAN	(	8	H	X	h	x
9	HT	EM	)	9	I	Y	i	y
A	LF	SUB	*	:	J	Z	j	z
B	VT	ESC	+	;	K	Æ	k	æ
C	FF	FS	,	<	L	Ø	l	ø
D	CR	GS	-	=	M	Å	m	å
E	SO	RS	.	>	N	Ü	n	ü
F	SI	US	/	?	O	_	o	DEL

APPENDIX 1 (Continued)

BRITISH

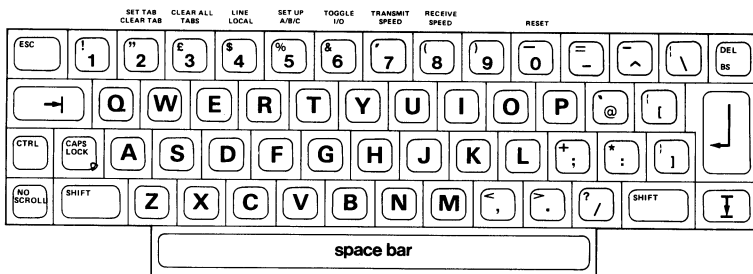

Hex	0	1	2	3	4	5	6	7
0	NUL	DLE	SP	0	@	P	.	p
1	SOH	DC1	!	1	A	Q	a	q
2	STX	DC2	"	2	B	R	b	r
3	ETX	DC3	£	3	C	S	c	s
4	EOT	DC4	\$	4	D	T	d	t
5	ENQ	NAK	%	5	E	U	e	u
6	ACK	SYN	&	6	F	V	f	v
7	BEL	ETB	'	7	G	W	g	w
8	BS	CAN	(	8	H	X	h	x
9	HT	EM	)	9	I	Y	i	y
A	LF	SUB	*	:	J	Z	j	z
B	VT	ESC	+	;	K	[	k	[
C	FF	FS	,	<	L	\	l	l
D	CR	GS	-	=	M	]	m	]
E	SO	RS	.	>	N	^	n	~
F	SI	US	/	?	O	_	o	DEL

SPANISH

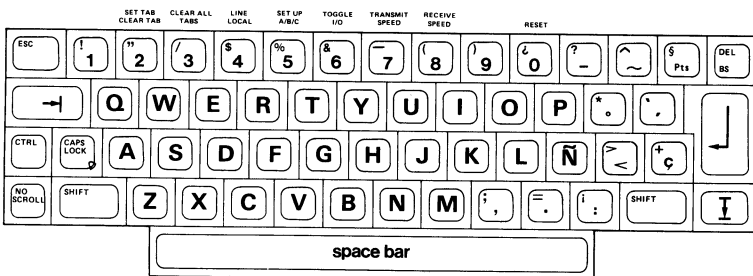

Hex	0	1	2	3	4	5	6	7
0	NUL	DLE	SP	0	\$	P	.	p
1	SOH	DC1	!	1	A	Q	a	q
2	STX	DC2	"	2	B	R	b	r
3	ETX	DC3	Pts	3	C	S	c	s
4	EOT	DC4	\$	4	D	T	d	t
5	ENQ	NAK	%	5	E	U	e	u
6	ACK	SYN	&	6	F	V	f	v
7	BEL	ETB	'	7	G	W	g	w
8	BS	CAN	(	8	H	X	h	x
9	HT	EM	)	9	I	Y	i	y
A	LF	SUB	*	:	J	Z	j	z
B	VT	ESC	+	;	K	[	k	[
C	FF	FS	,	<	L	Ñ	l	ñ
D	CR	GS	-	=	M	¿	m	ç
E	SO	RS	.	>	N	^	n	~
F	SI	US	/	?	O	_	o	DEL

FRENCH

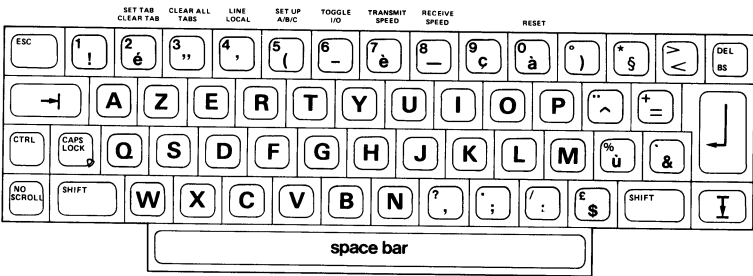

Hex	0	1	2	3	4	5	6	7
0	NUL	DLE	SP	0	à	P	.	p
1	SOH	DC1	!	1	A	Q	a	q
2	STX	DC2	"	2	B	R	b	r
3	ETX	DC3	£	3	C	S	c	s
4	EOT	DC4	\$	4	D	T	d	t
5	ENQ	NAK	%	5	E	U	e	u
6	ACK	SYN	&	6	F	V	f	v
7	BEL	ETB	'	7	G	W	g	w
8	BS	CAN	(	8	H	X	h	x
9	HT	EM	)	9	I	Y	i	y
A	LF	SUB	*	:	J	Z	j	z
B	VT	ESC	+	;	K	[	k	[
C	FF	FS	,	<	L	ç	l	ù
D	CR	GS	-	=	M	\$	m	è
E	SO	RS	.	>	N	^	n	~
F	SI	US	/	?	O	_	o	DEL

NORWEGIAN

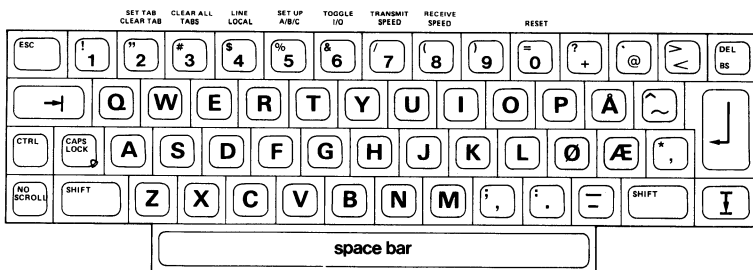

Hex	0	1	2	3	4	5	6	7
0	NUL	DLE	SP	0	@	P	.	p
1	SOH	DC1	!	1	A	Q	a	q
2	STX	DC2	"	2	B	R	b	r
3	ETX	DC3	#	3	C	S	c	s
4	EOT	DC4	\$	4	D	T	d	t
5	ENQ	NAK	%	5	E	U	e	u
6	ACK	SYN	&	6	F	V	f	v
7	BEL	ETB	'	7	G	W	g	w
8	BS	CAN	(	8	H	X	h	x
9	HT	EM	)	9	I	Y	i	y
A	LF	SUB	*	:	J	Z	j	z
B	VT	ESC	+	;	K	Æ	k	æ
C	FF	FS	,	<	L	Ø	l	ø
D	CR	GS	-	=	M	Å	m	å
E	SO	RS	.	>	N	^	n	~
F	SI	US	/	?	O	_	o	DEL

## APPENDIX 2

### SUMMARY OF TERMINAL CONTROL FUNCTIONS

No.	Name	Codes - ANSI	Custom	Reassigned	Page
<b>CURSOR MOVEMENT AND SCREEN CONTROL</b>					
1	Cursor Up	1B 5B Pn 41		1B 41	56
2	Cursor Down	1B 5B Pn 42		1B 42	56
3	Cursor Forward	1B 5B Pn 43		1B 43	56
4	Cursor Backward	1B 5B Pn 44		1B 44	56
5	Reserved				
-	Cursor Position, ANSI	1B 5B Pnl 3B Pnc 48			57
6	Cursor Position, VT52	-		1B 59 Pc Pl	57
7	Cursor Position, ADM 3A	-		<com> Pr Pc	57
8	Cursor Position, ADDS	-		<com> Pr Pc	57
9	Cursor Position, H1500	-		<com> Pc Pr	58
10	Cursor Position, TDV2215/20	-		10 Pr Pc	58
11	Reserved				
-	Horiz. and Vert. Position	1B 5B Pnl 3B Pnc 66		N/a	58
12	Cursor Home	1B 5B 48		1B 48	58
13	Save Cursor	1B 37		Same	58
14	Restore Cursor	1B 38		Same	59
15	Cursor Off	1B 5B 3F 33 35 68		Same	59
16	Cursor On	1B 5B 3F 33 35 6C		Same	59
17	Cursor Blink	1B 5B 3F 33 34 68		Same	59
18	Cursor Steady	1B 5B 3F 33 34 6C		Same	59
19	Cursor Underline	1B 5B 3F 33 33 68		Same	60
20	Cursor Block	1B 5B 3F 33 33 6C		Same	60
21	Reserved				
<b>VERTICAL COMMANDS</b>					
-	Index	1B 44		N/a	60
22	Next Line	1B 45		1B 5C	60
23	Reverse Index	1B 40		1B 49	60
24	Reserved				
25	Reserved				
26	Reserved				
<b>TABULATION</b>					
27	Set Tab Stop	1B 48		1B 74	61
28	Clear All Tab Stops	1B 5B Ps 67		None	61
29	Tabulation Forward	09		Same	61
30	Tabulation Backward	1B 42		1B 63	62
31	Set Margin Bell Position	1B 5B 3F 42		Same	62
32	Enable Margin Bell	1B 5B 3F 33 37 6C		Same	62
33	Disable Margin Bell	1B 5B 3F 33 37 68		Same	62
34	Reserved				

No.	Name	Codes - ANSI	Custom	Reassigned	Page
<b>SCREEN AND SCROLLING</b>					
35	Screen Background - Light	1B 5B 3F 35 68	Same		64
36	Screen Background - Dark	1B 5B 3F 35 6C	Same		64
37	Screen On	1B 5B 3F 33 36 6C	Same		64
38	Screen Off	1B 5B 3F 33 36 68	Same		64
39	Set Page Mode	1B 5B 3F 33 32 68	1B 34		64
40	Set Scroll Mode	1B 5B 3F 33 32 6C	1B 35		65
-	Set Scrolling Region	1B 5B Pnt 3B Pnb 72	Same		65
-	Set Left and Right Margins	1B 5B Pnl 3B Pnr 76	Same		65
41	Set Smooth Scroll	1B 5B 3F 34 68	1B 3A		65
42	Set Jump Scroll	1B 5B 3F 34 6C	1B 3B		65
43	Reserved				
44	Reserved				
45	Enable Origin Mode	1B 5B 3F 36 68	Same		66
46	Disable Origin Mode	1B 5B 3F 36 6C	Same		66
47	Wrap Enable	1B 5B 3F 37 68	1B 33		66
48	Wrap Disable	1B 5B 3F 37 6C	1B 32		66
49	New Line Enable	1B 5B 32 30 68	Same		67
50	New Line Disable	1B 5B 32 30 6C	Same		67
51	Reserved				
52	Reserved				
<b>KEYBOARD</b>					
53	Keyboard Lock	1B 5B 32 68	1B 66		77
54	Keyboard Unlock	1B 5B 32 6C	1B 65		77
55	Auto-Repeat On	1B 5B 3F 38 68	Same		78
56	Auto-Repeat Off	1B 5B 3F 38 6C	Same		78
57	Keypad Numeric Mode	1B 3E	Same		78
58	Keypad Application Mode	1B 3D	Same		78
-	Cursor Keys - Application	1B 5B 3F 31 68	N/a		78
-	Cursor Keys - Cursor	1B 5B 3F 31 6C	N/a		79
59	Reserved				
60	Reserved				
<b>KEYBOARD LEDs</b>					
-	Load Programmable LEDs	1B 5B Ps 3B...71	N/a		79
61	Flash LEDs	1B 5B 3F Ps 3B...74	None		79
62	Reserved				
63	Reserved				
64	Extinguish All LEDs	1B 5B 30 71	Same		80
65	Light LED 1	1B 5B 31 71	Same		80
66	Light LED 2	1B 5B 32 71	Same		80
67	Light LED 3	1B 5B 33 71	Same		80
68	Light LED 4	1B 5B 34 71	Same		80

No.	Name	Codes - ANSI	Custom	Reassigned	Page
<b>EDITING</b>					
69	Erasure Mode - Unprotected	1B 5B 36 6C	Same		81
70	Erasure Mode - All	1B 5B 36 68	Same		81
71	Erase in Display	1B 5B Ps 4A	1B 4A		82
72	Erase in Line	1B 5B Ps 4B	1B 4B		82
73	Home and Clear (= Ps 0)	1B 5B Ps 58	1B 4C		82
74	Home and Clear (= Ps 1)	1B 5B Ps 58	1B 58		82
75	Delete Character	1B 5B Pn 50	1B 22		83
76	Delete Word	1B 5B 57	1B 4D		83
77	Delete Line	1B 5B Pn 4D	1B 55		83
78	Insert Line	1B 5B Pn 4C	1B 54		83
79	Enter Insertion Mode	1B 5B 34 68	1B 21		84
80	Exit Insertion Mode	1B 5B 34 6C	18		84
81	Erase Page	N/a	None		84
82	Erase Line	N/a	None		84
<b>MULTIPAGE HANDLING</b>					
83	Select Flip Page Mode	1B 5B 3F 33 31 6C	Same		75
84	Select Big Page Mode	1B 5B 3F 33 31 68	Same		75
85	Advance Pages	1B 5B Pn 55	1B 75		75
86	Back Pages	1B 5B Pn 56	1B 76		76
87	Reserved				
88	Reserved				
<b>LINE ATTRIBUTES</b>					
89	Double Size Line - Top	1B 23 33	Same		86
90	Double Size Line - Bottom	1B 23 34	Same		86
91	Single-Width Line	1B 23 35	Same		86
92	Double-Width Line	1B 23 36	Same		86
93	Reserved				
94	Reserved				
<b>CHARACTER ATTRIBUTES</b>					
-	Select Video Attributes - ANSI	1B 5B Ps 3B...6D	N/a		87
95	Sel. Video Attributes - Custom	N/a	1B 53 Ps		87
96	Start Bold Intensity	N/a	1B 2C		88
97	End Bold Intensity	N/a	1B 2B		88
98	Start Blinking	N/a	1B 29		88
99	End Blinking	N/a	1B 2A		88
100	Start Reverse Video	N/a	1B 27		88
101	End Reverse Video	N/a	1B 28		89
102	Start Underline	N/a	1B 25		89
103	End Underline	N/a	1B 26		89
104	Underline Current Character	N/a	1B 2D		89
105	Start Security Field	1B 5B 31 73	Same		89
106	End Security Field	1B 5B 30 73	Same		90

No.	Name	Codes - ANSI	Custom	Reassigned	Page
<b>PROTECTION ATTRIBUTES AND FORMAT MODE</b>					
107	Reserved				
108	Enter Protection Mode				
-	- Custom	N/a	1B 2E		93
-	Format Mode - ANSI				
	Protected Attributes	1B 5B Ps 7D	N/a		93
109	Exit Protection Mode				
	- Custom & ANSI	1B 5B 30 7D	1B 2F		94
110	Bold Protected	1B 5B 31 7D	Same		94
111	Underline Protected	1B 5B 34 7D	Same		94
112	Blink Protected	1B 5B 35 7D	Same		94
113	Reverse Video Protected	1B 5B 37 7D	Same		94
114	All Attributes Off Protected	1B 5B 32 35 34 7D	Same		95
115	Blank Protected	N/a	None		95
116	Reset Custom Protected				
	Attributes	N/a	None		95
<b>FIELD ATTRIBUTES</b>					
117	Reserved				
118	Reserved				
119	Reserved				
120	Reserved				
121	Reserved				
<b>CHARACTER SET SELECTION</b>					
SELECT CHARACTER SET - ANSI					91
-	Select Std. Graphics as G0	1B 28 30	-		
-	Select Exp. ASCII as G0	1B 28 31	-		
-	Select Exp. Graphics as G0	1B 28 32	-		
-	Select Std. Graphics as G1	1B 29 30	-		
-	Select Exp. ASCII as G1	1B 29 31	-		
-	Select Exp. Graphics as G1	1B 29 32	-		
SELECT CHARACTER SET - CUSTOM					
122	Enter Semi-Graphics	-	1B 46		92
123	Exit Semi-Graphics	-	1B 47		92
124	Select Alternate Char. Gen.	-	0E		92
125	Select Standard Char. Gen.	-	0F		92
126	Reserved				
127	Reserved				

No.	Name	Codes - ANSI	Custom	Reassigned	Page
<b>OPERATOR STATUS</b>					
<b>STATUS LINE</b>					
128	Status Line On	1B 5B 3F 34 30 6C	Same		69
129	Status Line Off	1B 5B 3F 34 30 68	Same		70
130	Status Line - Status	1B 5B 3F 34 31 6C	Same		70
131	Status Line - User	1B 5B 3F 34 31 68	Same		70
132	Cursor Position On	1B 5B 3F 34 32 6C	Same		70
133	Cursor Position Off	1B 5B 3F 34 32 68	Same		70
134	Time On	1B 5B 3F 34 33 6C	Same		71
135	Time Off	1B 5B 3F 34 33 68	Same		71
136	Printer Status On	1B 5B 3F 34 35 6C	Same		71
137	Printer Status Off	1B 5B 3F 34 35 68	Same		71
138	Transmit Mode On	1B 5B 3F 34 36 6C	Same		71
139	Transmit Mode Off	1B 5B 3F 34 36 68	Same		72
140	Interface Monitor On	1B 5B 3F 34 37 6C	Same		72
141	Interface Monitor Off	1B 5B 3F 34 37 68	Same		72
142	I/O Buffer Monitor On	1B 5B 3F 34 38 6C	Same		72
143	I/O Buffer Monitor Off	1B 5B 3F 34 38 68	Same		72
-	Terminal Mode On	1B 5B 3F 34 39 6C	Same		73
-	Terminal Mode Off	1B 5B 3F 34 39 68	Same		73
144	Reserved				
145	Reserved				
146	Reserved				
147	Reserved				
148	Load User Status Line	1B 5B 3F 4C	Same		73
-	Load Time	1B 5B 3F Ph 3B Pm 54	Same		73
149	Reserved				
<b>MODES</b>					
150	Enter ANSI Mode	N/a	1B 3C		
-	Enter Custom Mode	1B 5B 3F 32 6C	N/a		
-	Set Mode 1	1B 5B 3F Ps 3B...68	-		97
-	Reset Mode 1	1B 5B 3F Ps 3B...6C	-		97
-	Set Mode 2	1B 5B Ps 3B Ps...68	-		101
-	Reset Mode 2	1B 5B Ps 3B Ps...6C	-		101



No.	Name	Codes - ANSI	Custom	Reassigned	Page
<b>REPORT COMMANDS</b>					
152	Cursor Position Report	1B 5B 36 6E	1B 45		103
153	Reserved				
154	Reserved				
155	Reserved				
156	Reserved				
157	Report Display Mode	1B 5B 3F 31 6E	Same		103
	Landscape Response	1B 5B 3F 4C 6E	Same		103
	Portrait Response	1B 5B 3F 50 6E	Same		103
158	Device Status Report	1B 5B 35 6E	Same		104
	Device St. Report Response	1B 5B Ps 6E	Same		104
159	Device Attributes	1B 3B Pn 63 or 1B 5A 1B 5A			104
	Device Attributes Response	1B 5B 3F 31 3B 32 63			104
160	Printer Status Report	1B 5B 3F 31 35 6E	Same		104
	Printer Ready Response	1B 5B 3F 31 30 6E	Same		104
	Printer Busy Response	1B 5B 3F 31 31 6E	Same		104
	Printer Not Connected	1B 5B 3F 31 33 6E	Same		104
161	Reserved				
162	Load Response	1B 5B 3F Ps 4D Str 7F	Same		105
<b>RESET AND TEST</b>					
163	Reset Terminal	1B 63	1B 30		107
-	Screen Alignment Display	1B 23 38	Same		107
-	Invoke Tests	1B 5B 32 3B 39 79	Same		107
-	Request Terminal Parameters	1B 5B 31 78	Same		108
	Request Terminal Parameters Response	1B 5B Ps 3B Par I/O 3B nbits I/O 3B xspeed I/O 3B rspeed I/O 3B 31 3B 30 3B mode 3B Par Pr 3B nbits Pr 3B xspeed Pr 3B rspeed Pr 78	Same		108
164	Reserved				
165	Reserved				
<b>DOWNLINE LOADING</b>					
-	User Definable Function Keys	1B 7F 35 31 20 Pn 3A	Same		113
-	Command Codes	delim. string delim. 1B 7F 36 31 20 Fnr 3A delim. code delim.	Same		114
-	Report EAROM	1B 5B 3F 75	Same		114

No.	Name	Codes - ANSI	Custom	Reassigned	Page
<b>PRINT COMMANDS</b>					
166	Print Line	1B 5B 3F 31 69	1B 56		109
167	Print Page	1B 5B 69	1B 5D		109
168	Enter Auto-print Mode	1B 5B 3F 35 69	1B 5E		110
169	Exit Auto-print Mode	1B 5B 3F 34 69	1B 5F		110
170	Enter Printer Controller Mode	1B 5B 35 69	1B 67		110
171	Exit Printer Controller Mode	1B 5B 34 69	1B 68		110
172	Enter Expanded Print Mode	1B 5B 32 32 68	Same		110
173	Exit Expanded Print Mode	1B 5B 32 32 6C	Same		111
174	Print Termination - FF	1B 5B 31 38 68	Same		111
175	Print Termination - None	1B 5B 31 38 6C	Same		111
176	Print Extent - Screen	1B 5B 31 39 68	Same		111
177	Print Extent - Region	1B 5B 31 39 6C	Same		111
178	Print Active Page	1B 5B 32 31 6C	Same		112
179	Print All Pages	1B 5B 32 31 68	Same		112
180	Reserved				
181	Reserved				
182	Reserved				
183	Reserved				
<b>SEND PARAMETERS</b>					
184	Send Mode - Interactive	1B 5B 3F 31 30 6C	Same		98
185	Send Mode - Block	1B 5B 3F 31 30 68	Same		98
186	Send Key = Block	1B 5B 3F 33 30 68	Same		98
187	Send Key = Extent	1B 5B 3F 33 30 6C	Same		98
188	Send Extent - Line	1B 5B 3F 31 31 68	Same		98
189	Send Extent - Page	1B 5B 3F 31 31 6C	Same		98
190	Send All Line/Page	1B 5B 31 36 68	Same		102
191	Send To Cursor	1B 5B 31 36 6C	Same		102
192	Send Direct	1B 5B 3F 31 34 68	Same		98
193	Send Indirect	1B 5B 3F 31 34 6C	Same		98
194	Remote Send Command	1B 35	1B 3F		98
195	Space Compression On	1B 5B 3F 31 33 68	Same		98
196	Space Compression Off	1B 5B 3F 31 33 6C	Same		98
197	Send Unprotected Data	1B 5B 31 6C	Same		101
198	Send All Data	1B 5B 31 68	Same		101
199	Reserved				

No.	Name	Codes - ANSI	Custom	Reassigned	Page
<b>CONTROL CODES</b>					
200	Send Answerback Message	05	05		54
201	Sound Bell	07	07		54
202	Backspace	08	08		54
203	Line Feed	0A/0B/0C	0A/0B/0C		54
204	Carriage Return	0D	0D		54
205	Cancel Escape Sequence	18 (CAN) and 1A	1A		54
206	Lead-in Code	1B	1B		54
207	Control Sequence Introducer	1B 5B	1B 5B		54
-	Stop Host Transmission	13	13		54
-	Start Host Transmission	11	11		54
-	Stop Terminal Transmission	13	13		54
-	Start Terminal Transmission	11	11		54

## APPENDIX 3

### SUMMARY OF SET-UP FUNCTIONS

**Note:** Factory default settings are underlined.

#### SET-UP MODE A

CHANGE TABS  
CLEAR TABS  
SET MARGIN BELL POSITION

#### SET-UP MODE B

CURSOR	<u>Enabled</u>	Disabled
CURSOR	<u>Block</u>	Line
CURSOR	Steady	<u>Blink</u>
SCREEN BACKGROUND	<u>Reverse</u>	Normal Video
SCROLL	Smooth	<u>Jump</u>
SMOOTH SCROLL SPEED	Fast	<u>Slow</u>
BACKSPACE KEY	Delete	<u>Backspace</u>
RESERVED	Enabled	<u>Disabled</u>
AUTO REPEAT	<u>Enabled</u>	Disabled
STATUS LINE	On	<u>Off</u>
MARGIN BELL	Enabled	<u>Disabled</u>
KEYCLICK	<u>Enabled</u>	Disabled
AUTO PROTOCOL	<u>Enabled</u>	Disabled
PROTOCOL	<u>XON/XOFF</u>	Ready/Busy
XON/XOFF FROM HOST	<u>Protocol</u>	Data
PRINTER TO HOST	Enabled	<u>Disabled</u>
LOCAL ECHO	Enabled	<u>Disabled</u>
DATA RATE TO HOST	60 cps	<u>Unlimited</u>
DUPLEX	Half	<u>Full</u>
STOP BITS	2	<u>1</u>
DATA BITS	<u>8</u>	7
8th DATA BIT	(1) Mark	<u>(0) Space</u>
PARITY SENSE	Even	<u>Odd</u>
PARITY	Enabled	<u>Disabled</u>

#### SET-UP MODE C

SEND KEY	Block	<u>Extent</u>
SEND EXTENT	Line	<u>Page</u>
SEND REQUEST	Direct	<u>Indirect</u>
SEND	All	<u>Unprot. only</u>
SEND	All	<u>To Cursor</u>
TRANSPARENCY MODE	Enabled	<u>Disabled</u>
COMMAND MODE	<u>ANSI</u>	Custom
BIG/FLIP PAGE	BigPage	<u>Flip</u>

#### Status line

STATUS LINE	User	<u>Status</u>
CURSOR POSITION	Enabled	<u>Disabled</u>
TIME	Enabled	<u>Disabled</u>
TERMINAL MODE	<u>Enabled</u>	Disabled
PRINTER STATUS	Enabled	<u>Disabled</u>
TRANSMIT	Enabled	<u>Disabled</u>
INTERFACE	Enabled	<u>Disabled</u>
BUFFER %	Enabled	<u>Disabled</u>
PRINT KEY	Block	<u>Operation</u>
PRINT EXTENT	All	<u>Scrolling Region</u>
PRINT	All	<u>To Cursor</u>
STOP BITS	2	<u>1</u>

#### Printer

DATA BITS 8/7	8	<u>7</u>
8th DATA BIT	1 (Mark)	<u>0 (Space)</u>
PARITY SENSE	Even	<u>Odd</u>
PARITY	Enabled	<u>Disabled</u>

#### CUSTOM MODE SET-UP 4

WRAP-AROUND	Enabled	<u>Disabled</u>
NEWLINE	Enabled	<u>Disabled</u>
DISPLAY REPORT	<u>Request</u>	Auto
PAGE MODE	Enabled	<u>Disabled</u>
PRINT TERMINATOR	FF	<u>None</u>
PRINT EXPAND	Enabled	<u>Disabled</u>
SCREEN SAVER	Enabled	<u>Disabled</u>
PRINT KEY OPERATION	Page	<u>Line</u>
PRINT PAGE	All	<u>Active</u>
EDIT KEYS	<u>Duplex</u>	Local
ATTRIBUTES OFF	Enabled	<u>Disabled</u>
PROTECTED	Enabled	<u>Disabled</u>
BLANK PROT.	Enabled	<u>Disabled</u>
BOLD PROTECTED	Enabled	<u>Disabled</u>
BLINK PROTECTED	Enabled	<u>Disabled</u>
REVERSE PROTECTED	Enabled	<u>Disabled</u>
UNDERLINE PROTECTED	Enabled	<u>Disabled</u>



## APPENDIX 4

### CONTROL AND CHARACTER CODE TABLES

**CONTROL CODE TABLE**

DEC	OCT	HEX	BINARY	ASCII CONTROL CHAR	KEY OR KEY COMBINATION
000	000	00	0000000	NUL	[CTRL]+[@]**
001	001	01	0000001	SOH	[CTRL]+[A]
002	002	02	0000010	STX	[CTRL]+[B]
003	003	03	0000011	ETX	[CTRL]+[C]
004	004	04	0000100	EOT	[CTRL]+[D]
005	005	05	0000101	ENQ	[CTRL]+[E]
006	006	06	0000110	ACK	[CTRL]+[F]
007	007	07	0000111	BEL	[CTRL]+[G]
008	010	08	0001000	BS	[CTRL]+[H] or [BS]
009	011	09	0001001	HT	[CTRL]+[I] or [TAB]
010	012	0A	0001010	LF	[CTRL]+[J] or [LF]
011	013	0B	0001011	VT	[CTRL]+[K]
012	014	0C	0001100	FF	[CTRL]+[L]
013	015	0D	0001101	CR	[CTRL]+[M] or [RET]
014	016	0E	0001110	SO	[CTRL]+[N]
015	017	0F	0001111	SI	[CTRL]+[O]
016	020	10	0010000	DLE	[CTRL]+[P]
017	021	11	0010001	DC1	[CTRL]+[Q]
018	022	12	0010010	DC2	[CTRL]+[R]
019	023	13	0010011	DC3	[CTRL]+[S]
020	024	14	0010100	DC4	[CTRL]+[T]
021	025	15	0010101	NAK	[CTRL]+[U]
022	026	16	0010110	SYN	[CTRL]+[V]
023	027	17	0010111	ETB	[CTRL]+[W]
024	030	18	0011000	CAN	[CTRL]+[X]
025	031	19	0011001	EM	[CTRL]+[Y]
026	032	1A	0011010	SUB	[CTRL]+[Z]
027	033	1B	0011011	ESC	[CTRL]+[[]* or [ESC]
028	034	1C	0011100	FS	[CTRL]+[\\]*
029	035	1D	0011101	GS	[CTRL]+[]]*
030	036	1E	0011110	RS	[CTRL]+[']*
031	037	1F	0011111	US	[CTRL]+[ ]*

\*\* This key combination will not be transmitted by the terminal.

**\*National Variations**

US	SW/FI	GER	DK	UK/HOL	SP	FR	NOR
[CTRL]+@	[CTRL]+É	[CTRL]+§	[CTRL]+É	[CTRL]+@	[CTRL]+§	[CTRL]+à	[CTRL]+@
[	Ä	Ä	Æ	[	í	°	Æ
\	Ö	Ö	Ø	\	ñ	ç	Ø
]	Å	Ü	Å	] ^	¿	§	Å
^	Ü	^	Ü	^	^	^	^

**CHARACTER CODE TABLE**

DEC	OCT	HEX	BINARY	ASCII CHAR
032	040	20	0100000	SP
033	041	21	0100001	!
034	042	22	0100010	"
035	043	23	0100011	#*
036	044	24	0100100	\$*
037	045	25	0100101	%
038	046	26	0100110	&
039	047	27	0100111	'
040	050	28	0101000	(
041	051	29	0101001	)
042	052	2A	0101010	*
043	053	2B	0101011	+
044	054	2C	0101100	,
045	055	2D	0101101	-
046	056	2E	0101110	.
047	057	2F	0101111	/
048	060	30	0110000	0
049	061	31	0110001	1
050	062	32	0110010	2
051	063	33	0110011	3
052	064	34	0110100	4
053	065	35	0110101	5
054	066	36	0110110	6
055	067	37	0110111	7
056	070	38	0111000	8
057	071	39	0111001	9
058	072	3A	0111010	:
059	073	3B	0111011	;
060	174	3C	0111100	<
061	075	3D	0111101	=
062	076	3E	0111110	>
063	077	3F	0111111	?
064	100	40	1000000	@*
065	101	41	1000001	A
066	102	42	1000010	B
067	103	43	1000011	C
068	104	44	1000100	D
069	105	45	1000101	E
070	106	46	1000110	F
071	107	47	1000111	G
072	110	48	1001000	H
073	111	49	1001001	I
074	112	4A	1001010	J
075	113	4B	1001011	K
076	114	4C	1001100	L
077	115	4D	1001101	M
078	116	4E	1001110	N
079	117	4F	1001111	O

DEC	OCT	HEX	BINARY	ASCII CHAR
080	120	50	1010000	P
081	121	51	1010001	Q
082	122	52	1010010	R
083	123	53	1010011	S
084	124	54	1010100	T
085	125	55	1010101	U
086	126	56	1010110	V
087	127	57	1010111	W
088	130	58	1011000	X
089	131	59	1011001	Y
090	132	5A	1011010	Z
091	133	5B	1011011	[*
092	134	5C	1011100	\*
093	135	5D	1011101	]*
094	136	5E	1011110	~*
095	137	5F	1011111	_*
096	140	60	1100000	*a
097	141	61	1100001	a
098	142	62	1100010	b
099	143	63	1100011	c
100	144	64	1100100	d
101	145	65	1100101	e
102	146	66	1100110	f
103	147	67	1100111	g
104	150	68	1101000	h
105	151	69	1101001	i
106	152	6A	1101010	j
107	153	6B	1101011	k
108	154	6C	1101100	l
109	155	6D	1101101	m
110	156	6E	1101110	n
111	157	6F	1101111	o
112	160	70	1110000	p
113	161	71	1110001	q
114	162	72	1110010	r
115	163	73	1110011	s
116	164	74	1110100	t
117	165	75	1110101	u
118	166	76	1110110	v
119	167	77	1110111	w
120	170	78	1111000	x
121	171	79	1111001	y
122	172	7A	1111010	z
123	173	7B	1111011	[*
124	174	7C	1111100	*
125	175	7D	1111101	]*
126	176	7E	1111110	~*
127	177	7F	1111111	DEL

\*National Variations

US	SW/FI	GER	DK	UK/HOL	SP	FR	NOR
[	Ä	Ä	Æ	[	í	°	Æ
\	Ö	Ö	Ø	\	ñ	ç	Ø
]	Å	Ü	Å	]	¿	ç	Å
^	Ü	·	Ü	^	·	·	·
·	é	·	é	·	·	é	·
	ä	ä	æ		°	ù	æ
	ö	ö	ø		ñ	ù	ø
	å	ü	å		ç	·	å
~	ü	ß	ü	~	~	·	~

# APPENDIX 5 GRAPHICS MODE SYMBOLS

Entered Hex Code	Key	Symbol	Name	Stored Hex Code
5F	[SHIFT]+[~]*		Plotting dot	1F
60	`			7F
61	A		10 line block	01
62	B		8 line block	02
63	C		6 line block	03
64	D		4 line block	04
65	E		2 line block	05
66	F		Character size block	06
67	G		Plotting dot	07
68	H			08
69	I			09
6A	J		Lower right corner	0A
6B	K		Upper right corner	0B
6C	L		Upper left corner	0C
6D	M		Lower left corner	0D
6E	N		Crossing lines	0E

Entered Hex Code	Key	Symbol	Name	Stored Hex Code
6F	O		Horizontal line	0F
70	P			10
71	Q			11
72	R			12
73	S			13
74	T		Left T	14
75	U		Right T	15
76	V		Bottom T	16
77	W		Top T	17
78	X		Vertical bar	18
79	Y		Not greater than	19
7A	Z		Not less than	1A
7B	[SHIFT]+[{}]*		Pi	1B
7C	[SHIFT]+[\\]*		Not equal to	1C
7D	[SHIFT]+[~]*		Degree	1D
7E	[SHIFT]+[~]*		Plus or minus	1E

\*National Variations

US	SW/FI	GER	DK	UK/HOL	SP	FR	NOR
[SHIFT]+[~]	[SHIFT]+[~]	[SHIFT]+[~]	[SHIFT]+[~]	[SHIFT]+[0]	[SHIFT]+[7]	_	[SHIFT]+[~]
[SHIFT]+[{}]	Ä	Ä	Æ	[SHIFT]+[{}]	o	é	Æ
[SHIFT]+[\\]	Ö	Ö	Ø	[SHIFT]+[\\]	ñ	ù	Ø
[SHIFT]+[~]	Å	Ü	Å	[SHIFT]+[~]	ç	è	Å
[SHIFT]+[~]	Ü	ß	Ü	[SHIFT]+[^]	~	[SHIFT]+[^]	~







# Facit Twist Video Terminal

## FACIT

**Australia:** EAI-Electronic Associates Pty Ltd, P.O. Box 570, ARTARMON NSW 2064, Telephone 427-3322, Telex 21130 - **Austria:** Ericsson Information Systems Ges. m.b.H., Richard Strauss Str. 43, A-1232 VIENNA, Telephone 0222-613641, Telex 115907  
- **Belgium:** Ericsson S.A., Dept Imprimantes, Rue de la Fusée 40, 1130 BRUXELLES, Telephone 02-243.82.11, Telex 26519 - **Canada:** Facit Canada Inc., 1739 Argenta Road, MISSISSAUGA, ONTARIO, L5N 3B1, Telephone (416) 621-9400, Telex 06-218575  
- **Cyprus:** LBM (Lilytos) Ltd, P.O. Box 380, LIMASSOL, Telephone 5164634, Telex 2080 - **Denmark:** Facit A/S, Postbox 9, 2730 HERLEV, Telephone 02-922400, Telex 35394 - **Finland:** OY Facit AB, P.B. 279, SF-00181 HELSINGFORS, Telephone (90)-420 21, Telex 122080 - **France:** Facit S.A., 308, rue du Pdt, Salvador Allende, 92707 COLOMBES Cédex, Telephone (1) 780-71-17, Telex 610 286 - **Great Britain:** Facit, Maidstone Road, ROCHESTER, Kent ME13ON, Telephone 0634-401721, Telex 96447 - **Greece:** Computer Application Co. Ltd, Mesogeion Ave. 289, ATHENS, Telephone 01-6719722/23, Telex 219 349 - **Hong Kong:** Gilman & Co. Ltd, Office Machines Dept., Box 56, Elizabeth House, 4/F, G.P.O. HONG KONG, Telephone 5-8830022, Telex 63667 - **Iceland:** Gisli J. Johnsen, Skrifstofubúnaður SF, P.O. Box 132, IS-202 KOPAVOGUR, Telephone 354-173111, Telex 2316 - **India:** Forbes Forbes Campbell & Co. Ltd, Communications & Engineering, Imports, "Forbes Building", Charanjit Rai Marg, Fort, BOMBAY 400 001, Telephone 269081, Telex 011-2369 - **Ireland:** Memory Ireland Computers Ltd, Clonard House Sandyford Road, DUBLIN 14, Telephone 989733, Telex 30721 - **Italy:** Facit Data Products S.P.A. Centro Direzionale Colleoni, Palazzo Orione Ingresso 1, 200 41 AGRATE BRIANZA (Milano), Telephone 0039-39 63.63.31, Telex 326423 - **Japan:** Electrolux (Japan) Ltd, Facit Division, Gadelius Bldg, 7-8 Motoakasaka 1-Chome, Minato-ku, TOKYO, Japan 107, Telephone 479-3411, Telex 2424629 - **Korea:** K.D.C. Corporation, C.P.O. Box 5986, SEOUL, Telephone 723-8555/8236, Telex k 29429 - **The Netherlands:** Ericsson Information Systems B.V., Postbus 263, 3440 AG WOERDEN, Telephone 3480-70911, Telex 40203 - **New Zealand:** McLean Inform Technology Ltd, P.O. Box 9464, NEWMARKET AK, Telephone 501-801, 501-219, Telex 21570 - **Norway:** Ericsson Information Systems A/S, Avd. Facit, Postboks 6663, Rodeleikta, 0502 OSLO 5, Telephone 02-35 58 20, Telex 19449 - **Portugal:** Regisconta Sarl, Avenida Duque de Loulé 72, Apartado 2047, 1101 LISBOA Cédex, Telephone 1-560091, Telex 14306 - **Singapore:** Far East Office Equip Pte Ltd, Unit 10-03 Alpha Bldg, 45 Kallang Pudding Rd, SINGAPORE 1334, Telephone 749 82 88, Telex 244 11 - **South Africa:** Maynards Pty Ltd, P.O. Box 1055, CAPE TOWN 8000, Telephone 021-24 31 40, Telex 57-220 81 - **Spain:** Facit, Paseo de la Habana 138, 28036 MADRID, Telephone 4.57.11.11, Telex 47615 - **Sweden:** Head Office Facit AB, S-172 91 SUNDBYBERG, Telephone 08-764 30 00, Telex 12639, Sales Office, Ericsson Information Systems, Sverige AB, Avd. VMDD, Box 11100, S-161 11 BROMMA, Telephone 08-28 28 60, Telex 10485, Sweden - **Switzerland:** Ericsson Information Systems AG, Postfach 25, CH-8702 ZOLLIKON-STATION, Telephone 01-391.97.11, Telex 59142 - **Taiwan R.O.C.:** Dimension Computer Technology Co., 147 Chien Kuo North Rd, Sec. 2, Taipei 104, Telephone 2-945968, Telex 25117 - **Turkey:** Teknodata, Voyvoda Caddes 152, Karaköy, ISTANBUL, Telephone 49 17 66, 44 08 70, Telex 241 35 - **USA:** Facit Inc., P.O. Box 334, MERRIMACK, NH 03054, Telephone (603) 424-8000, Telex 692 8010 - **West Germany:** Ericsson Information, Systems GmbH, Vogelsanger Weg 91, P.O. Box 300229, 4000 DÜSSELDORF 30, Telephone 0211/6109-0, Telex 898 2415

We reserve the right to change specifications without notice.